

BIBUS

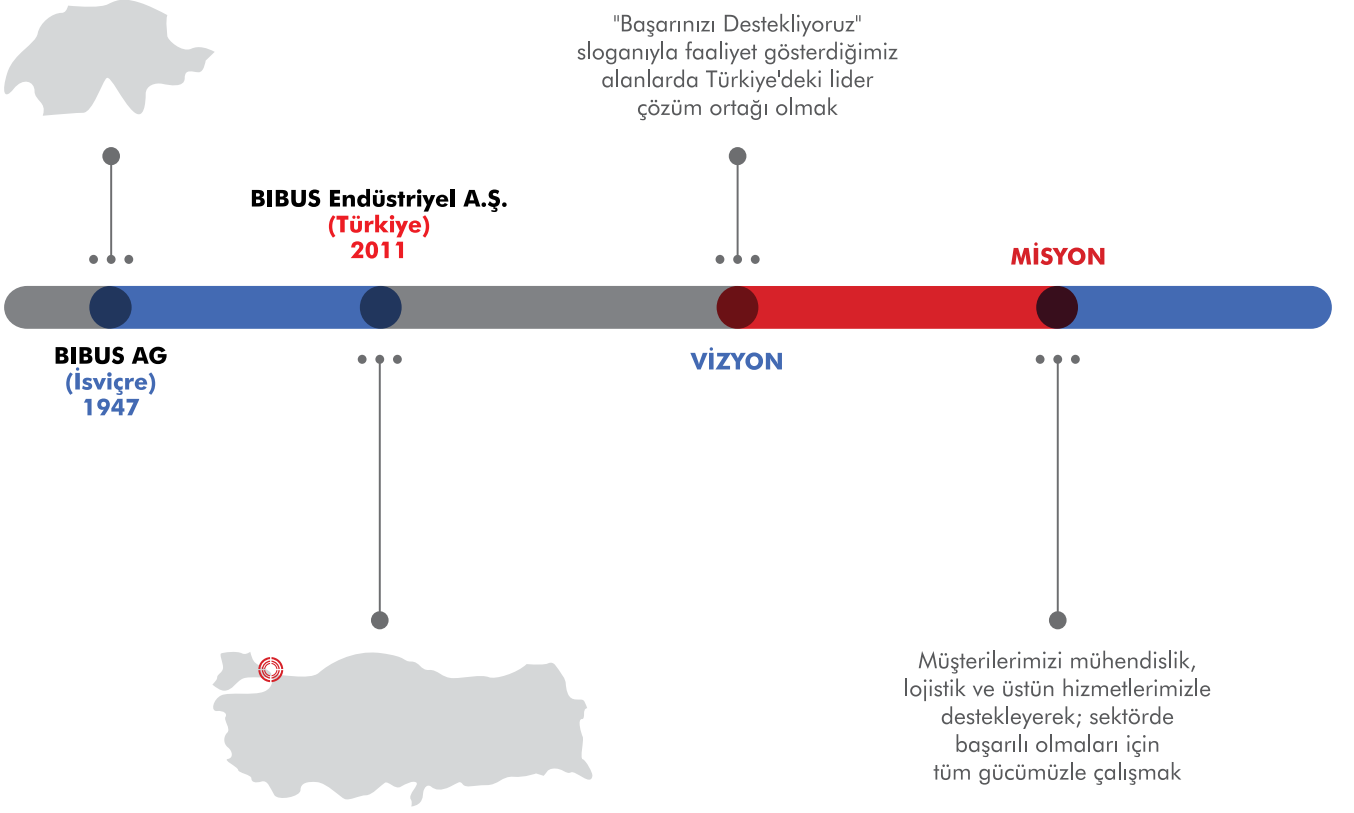

**MÜHENDİSLİK
LOJİSTİK
SERVİS**

**SMART OFFICE & HOME SOLUTION
STANDING DESK SYSTEMS
LIFTING TV BASE
LIFTING CABINET BASES
LIFTING COLUMN
LINEAR ACTUATORS**



BIBUS Türkiye

Başarınızı destekliyoruz

TEK TEDARİKÇİ • TEK TEMAS • TEK SORUMLULUK

BIBUS Holding AG, Avrupa ve Asya'daki lokasyonları ile birlikte İsviçre merkezli bir şirkettir. 1947 yılında Dipl. Ing. Hans Bibus tarafından, çelik ticareti amacı ile kurulmuş olan şirket; teknoloji, malzeme ve elektronik alanlarında faaliyet gösteren ilerici bir şirketler grubuna dönüşmüştür. Güvenilirliği ve yüksek kalite standartları sayesinde, yüksek kaliteli endüstriyel ürünler, bileşenler ve sistem çözümleri için pazarda lider tedarikçi ve hizmet ortağı olarak kendini kanıtlamıştır.

BIBUS Holding AG, iç ve dış ortaklarıyla birlikte büyümeye ve başarılarını güçlü bir şekilde destekler. Tüm şubeler, grubun uzmanlığına ve kaynaklarına erişebilir. Kendileri için, mühendislik, lojistik ve hizmet segmentlerindeki özel yerel yetkinlikleri ile müşterilerimizin ve tedarikçilerimizin performansına katkıda bulunurlar.

Ortaklarımız, genel müdürlerimiz ve çalışanlarımızla birlikte, "Başarınızı destekliyoruz" ilkemize dayanarak uzun vadeli istikrarlı bir geleceğe bağlıyız.

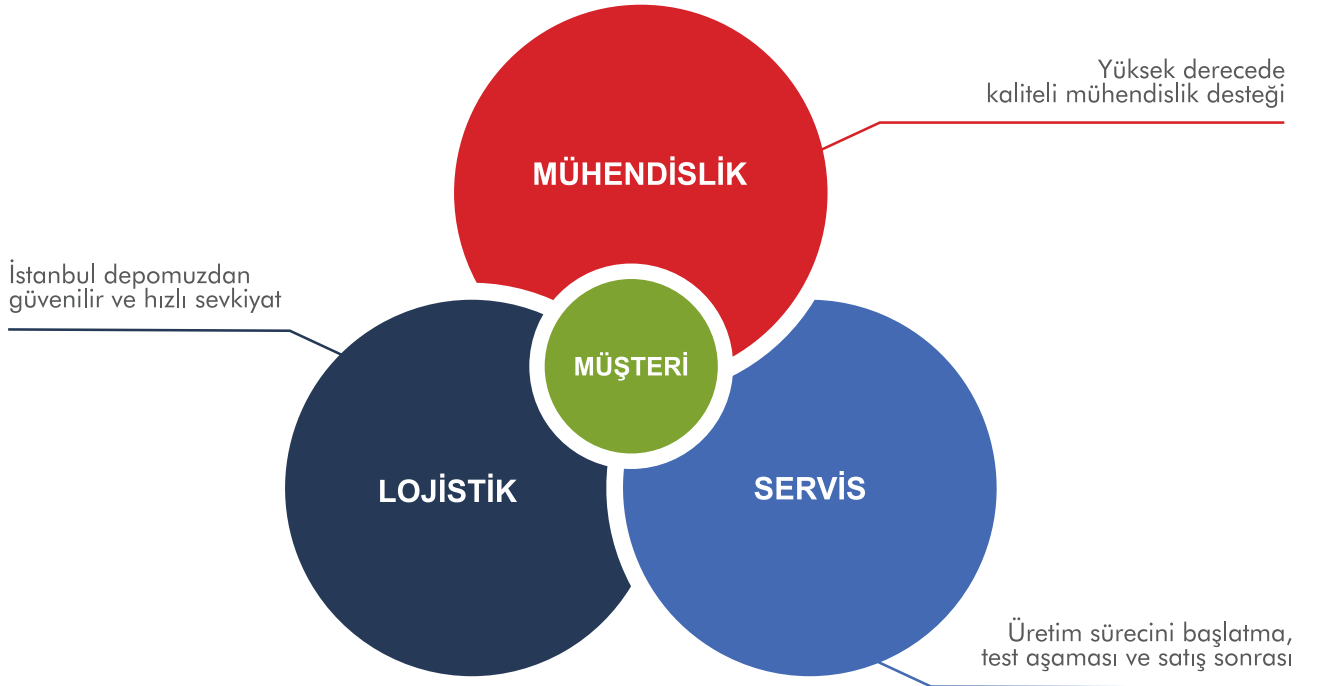

CERTIFICATION

BIBUS have passed ISO9001, ISO14001, ISO27001, OHSAS18001 and other management systems, and our products have passed UL, CE, ROHS, SAA, PSE, KC, BIFMA and other international certifications.





BBS35TS-R12S

DOUBLE-MOTOR OFFICE DESKS

SURFACE COLOR

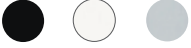

Black / White / Silver

•Option

The possibility of production with the given RAL code for high-volume orders

TECHNICAL PARAMETER

Height (mm)	685 ~ 1185	Width (mm)	1080 ~ 1800
Speed (mm/s)	32	Noise (dB)	≤50
Load Capacity (N)	1200		

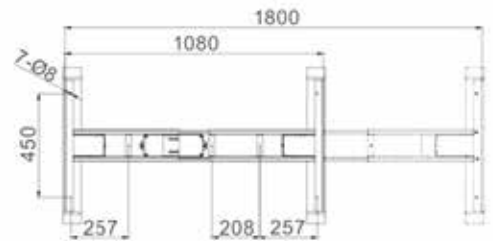
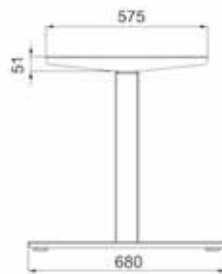
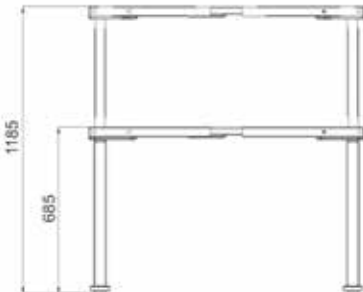

BBS35TS-R13S

DOUBLE-MOTOR OFFICE DESKS

SURFACE COLOR

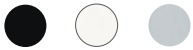

Black / White / Silver

•Option

The possibility of production with the given RAL code for high-volume orders

TECHNICAL PARAMETER

Height (mm)	575 ~ 1255	Width (mm)	1080 ~ 1800
Speed (mm/s)	32	Noise (dB)	≤50
Load Capacity (N)	1200		

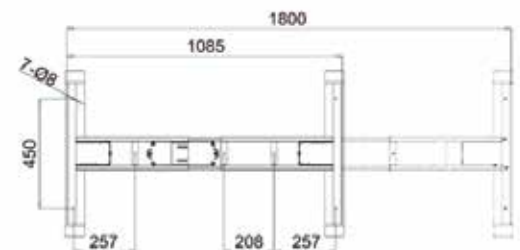
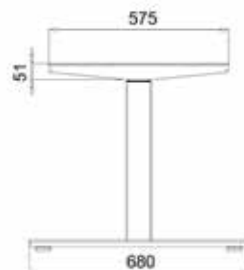
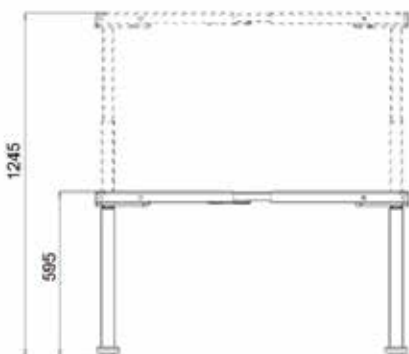

TT 90° BBS35TT-R13R-90°



 Width (mm)
1080 ~ 1800

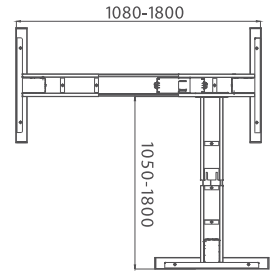
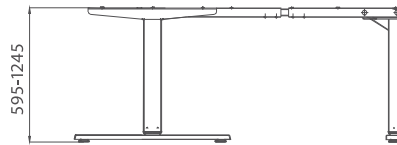

TT 120° BBS35TT-C13S-120°



 Width (mm)
1050 ~ 1900

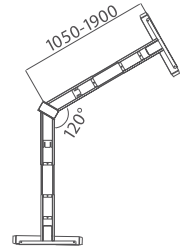
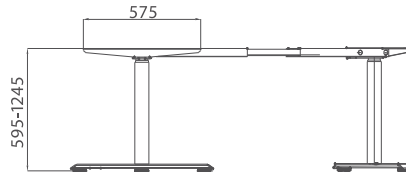

TT 180° BBS35TT-R12S-180°



 Width (mm)
1995 ~ 2995

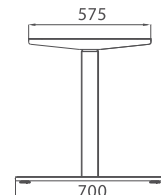
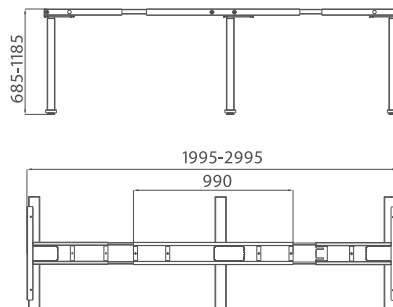

BIBUS



BBS35TF-R12S-2

FOUR-MOTORS OFFICE DESKS

SURFACE COLOR



Black / White / Silver

•Option

The possibility of production with the given RAL code for high-volume orders

TECHNICAL PARAMETER

Height	(mm)	Width	(mm)
685 ~ 1185		1100 ~ 1700	
Speed	(mm/s)	Noise	(dB)
32		<50	
Load Capacity	(N)		
1250			

DETAIL DISPLAY

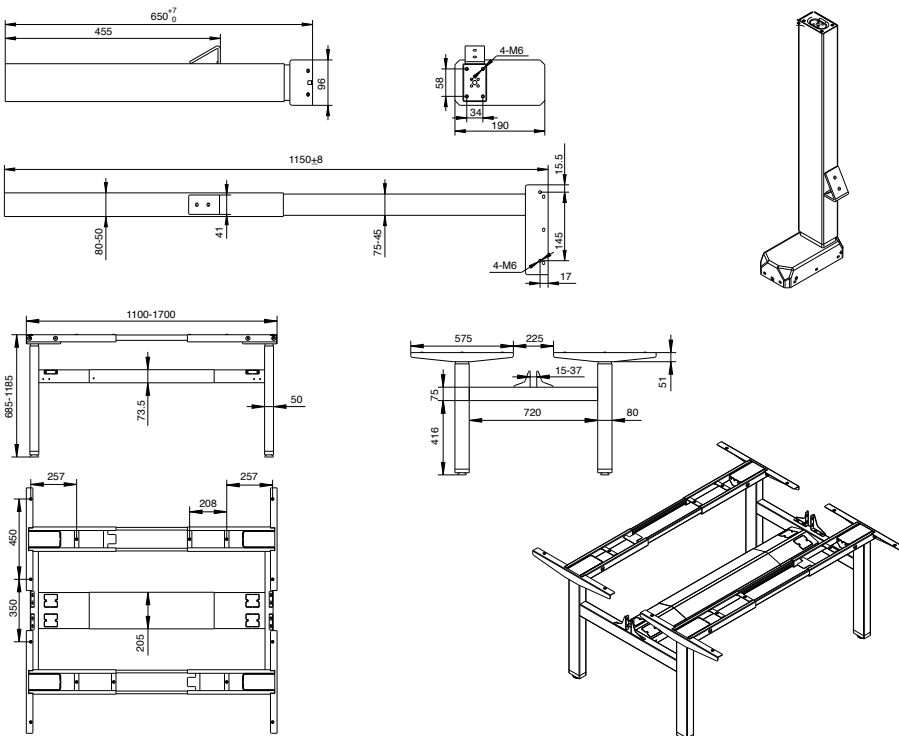

BBS35TF-R13S-2

FOUR-MOTORS OFFICE DESKS

SURFACE COLOR

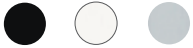

Black / White / Silver

•Option

The possibility of production with the given RAL code for high-volume orders

DETAIL DISPLAY

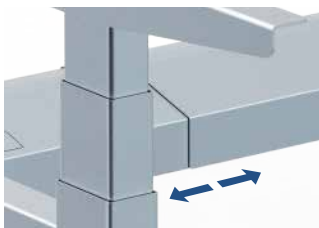

TECHNICAL PARAMETER

Height	(mm)	Width	(mm)
595 ~ 1255		1100 ~ 1700	
Speed	(mm/s)	Noise	(dB)
40		<50	
Load Capacity	(N)		
1250			

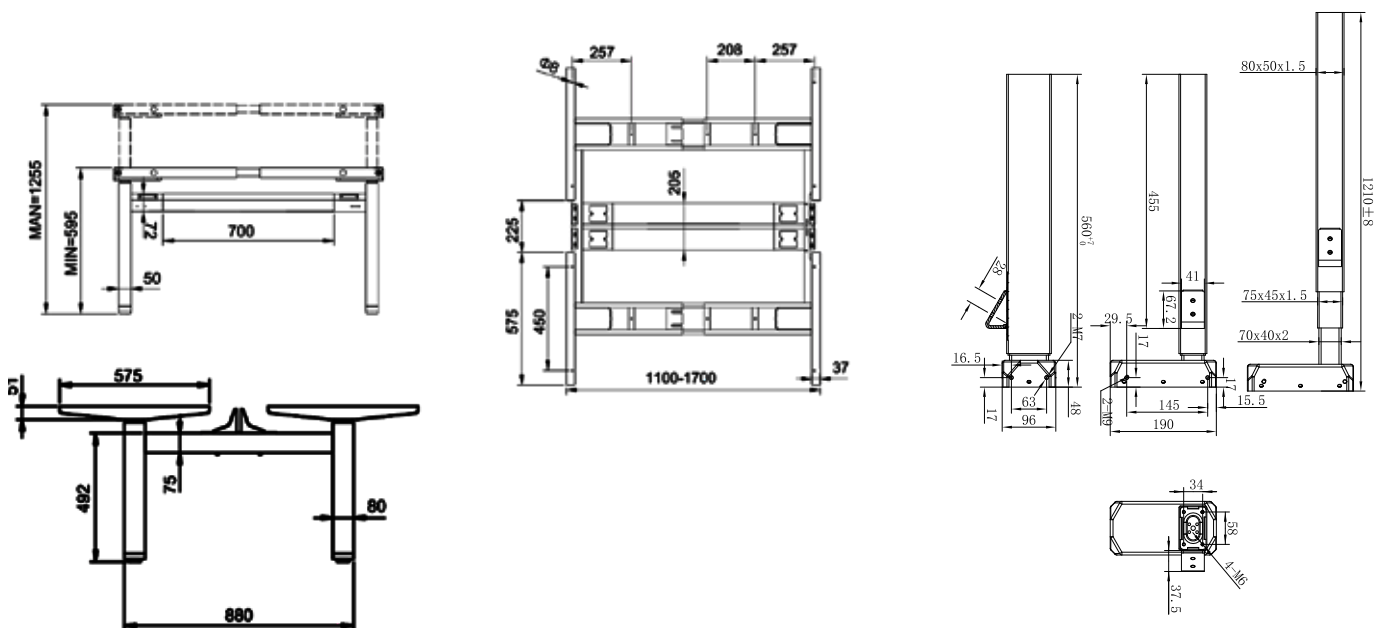



TT INTEGRATED WORKSTATION TRIPLET BBS35TT-R13S-120°

THREE-MOTORS OFFICE DESKS

SURFACE COLOR



Black / White / Silver

•Option

The possibility of production with the given RAL code for high-volume orders

TECHNICAL PARAMETER

	Height	(mm)
595 ~ 1245		
	Speed	(mm/s)
40		
	Load Capacity	(N)
1500		
	Width	(mm)
1080 ~ 1800		
	Noise	(dB)
<50		

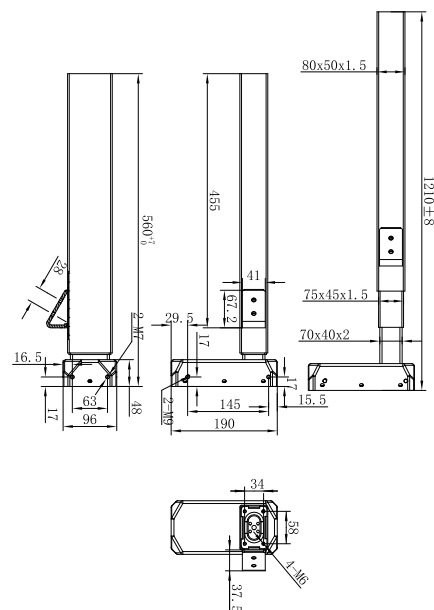
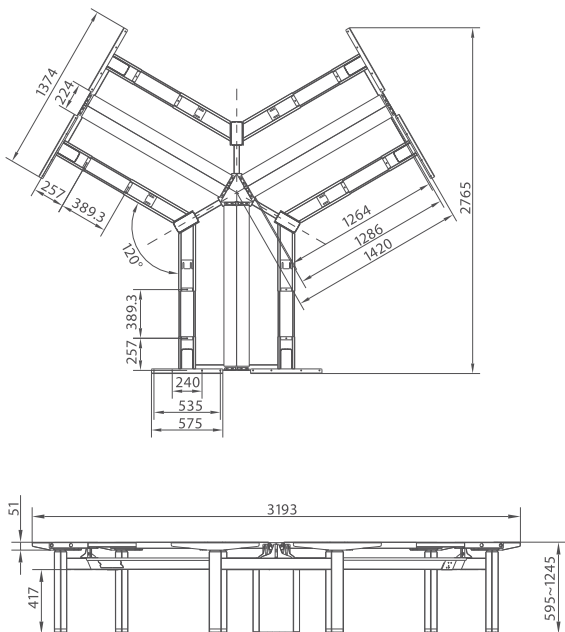
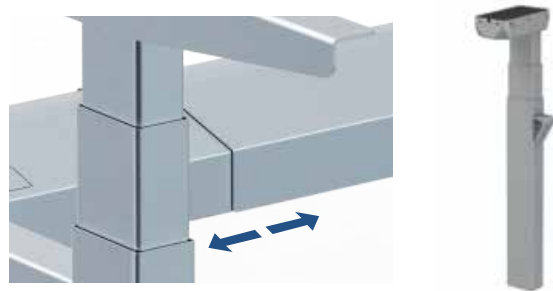
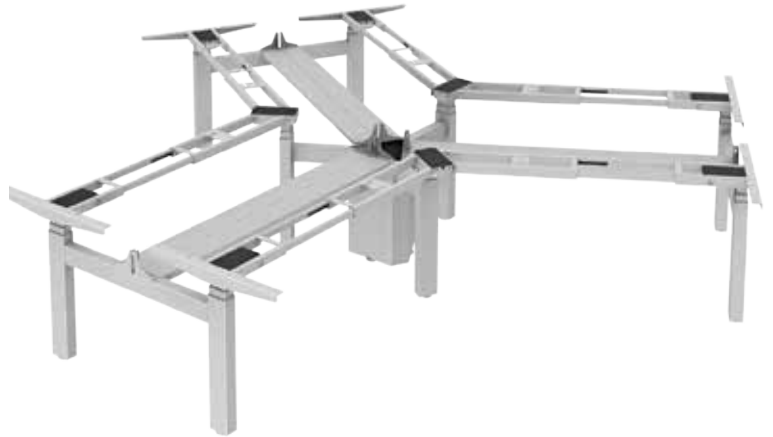



H-FRAME DESK-4 WORKSTATIONS BBS35TF-R13S-4 FOUR-MOTORS OFFICE DESKS

SURFACE COLOR

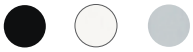

Black / White / Silver

•Option

The possibility of production with the given RAL code for high-volume orders

TECHNICAL PARAMETER

Height	(mm)	Width	(mm)
595 ~ 1255		1100 ~ 1700	
Speed	(mm/s)	Noise	(dB)
40		<50	
Load Capacity	(N)		
1250			

Features

- Adjustable height range: 595-1255mm
- Frame extendable range: 1100-1700mm
- No hold design leg, no screw on the outside of frame
- Load capacity: 1250N
- Max speed: 40mm/s
- Low noise level: <50dB with no-load condition
- Anti-collision safety protection
- Standby Power Loss: <0.1W
- Surface: powder coating with standard colors: White(RAL9016), Black(RAL9005), Grey(RAL7045)



DETAIL DISPLAY

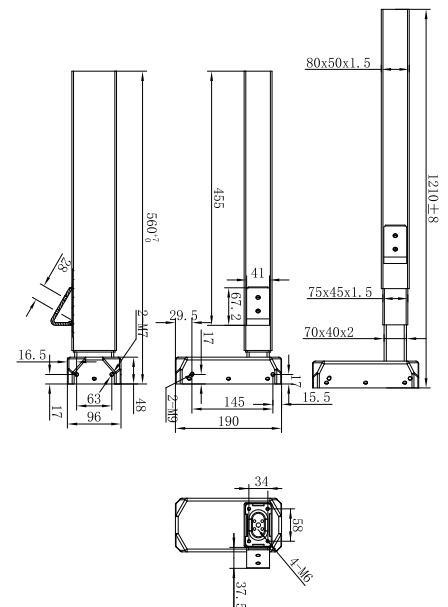
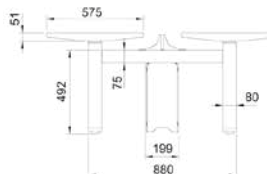
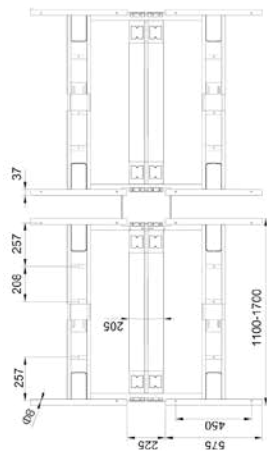
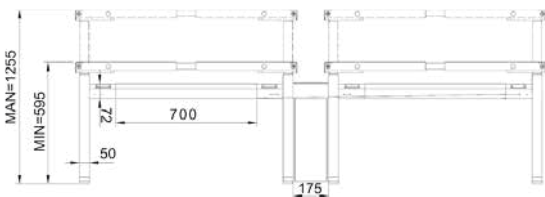
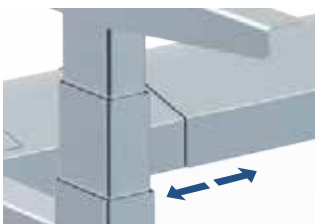

Desk BBS35TS-R12R

PRIMMER 5.1 ELECTRIC
HEIGHT-ADJUSTABLE DESK

SURFACE COLOR



Black / Silver

•Option

The possibility of production with the given RAL code for high-volume orders

Features

- Maximum load: 700N
- Equipped with BIBUS control box, no-load & load speed: 25mm/s
- Noise: ≤53dB
- Maximum lateral force: 100N.m
- Standard installation distance: 657mm
- Standard stroke: 480mm
- Outer tube size: 60×45mm
- Motor: BIBUS self-made motor
- With Hall feedback
- Surface: spray, standard color: white, black and gray



Dimensions

Without desktop

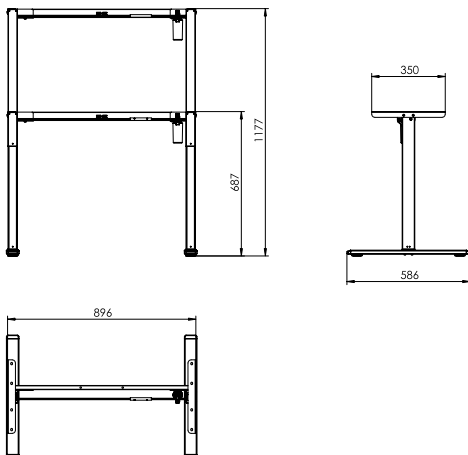

With desktop

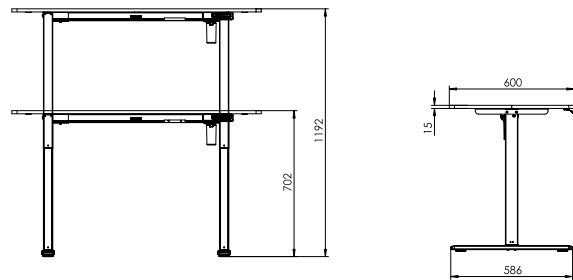

Technical specifications

Model	Load (N)	Self-lock (N)	Rated load current (A)	Maximum speed no load~rated load (mm/s)	Duty cycle	Stroke (mm)	Min. height (mm)
BBS35TS-R12R	700	700	4	25	10%	480	657

COFFEE STANDING DESK

Features

- Load: 800N
- Speed: 25mm/s
- Noise: ≤50dB
- Maximum lateral force: 100N.m
- Standard mounting distance: 480mm
- Standard stroke: 265mm
- Outer tube dimensions: 60mm*60mm
- Drawer size: 580mm*273mm*50mm
- Motor: BIBUS high-power motor
- Surface: Powder coating, Standard color: white, black



Dimensions

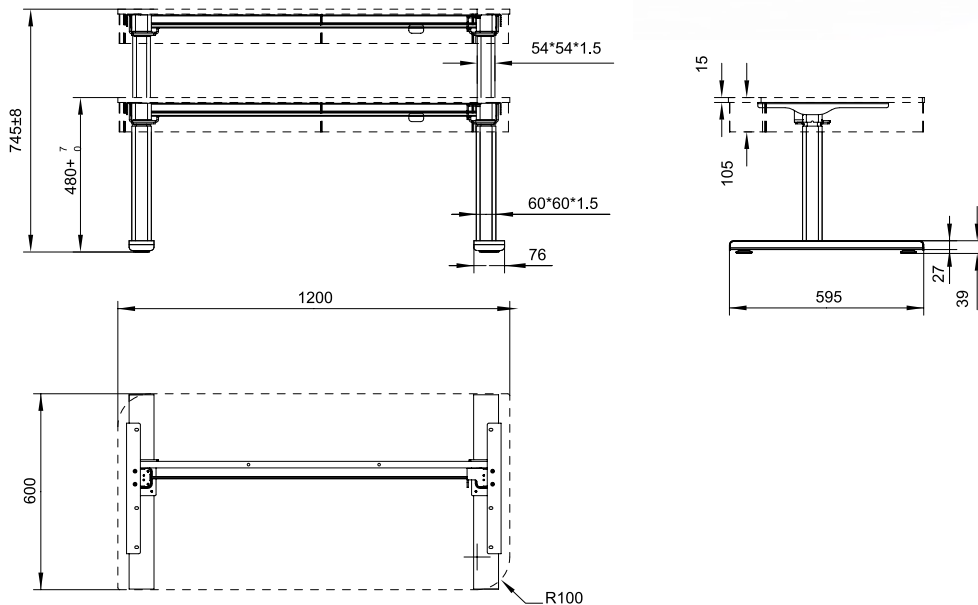

Technical specifications

Model	Load (N)	Self-lock (N)	Rated load current (A)	Maximum speed no load~rated load (mm/s)	Duty cycle	Stroke (mm)	Min. height (mm)
Coffee	800	1200	4	25	10%	475	685

BBS35TS-S112R

QUARTZS 3.0

Features

- Load: 800N
- Speed: 25mm/s
- Noise: s50dB
- Maximum lateral force: 100N.m
- Standard mounting distance: 685mm
- Standard stroke: 475mm
- Outer tube dimensions: 66x66mm
- Motor: BIBUS high-power motor
- Surface: Powder coating, Standard color: white, black
- Black glass
- White glass
- Wooden



Dimensions

Glass version

Wooden version

Dimensions

Glass version

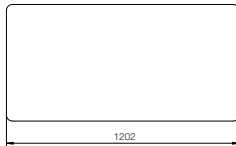
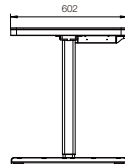
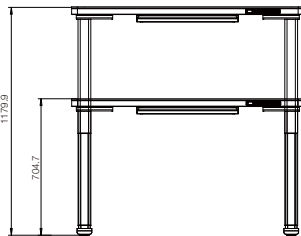

Wooden version

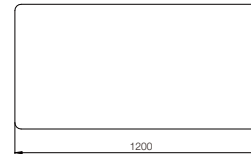
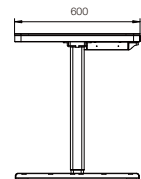
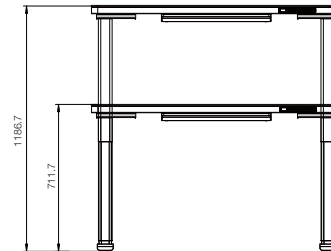

Technical specifications

Model	Load (N)	Self-lock (N)	Rated load current (A)	Maximum speed no load~rated load (mm/s)	Duty cycle	Stroke (mm)	Min. height (mm)
JC35TS-S112R	800	1200	4	25	10%	475	685

BBS35TS-S32S

QUARTZS 2.0

Features

- Rated load: 1000N
- Static loading: 2000N
- Max. speed: 32mm/s
- Noise: s 53dB
- Frame size: 1600X800mm(Do not stretch)
- Height Range: 670-1120mm
- Surface: powder-coating
- Standard colors: black, white



Dimensions

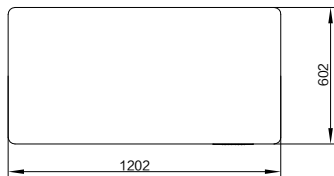
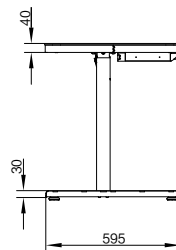
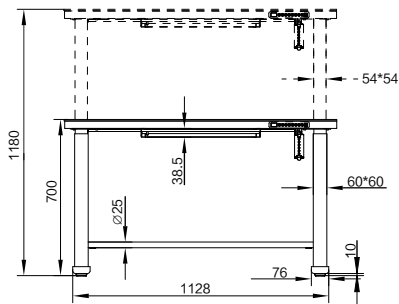

Performance Curve

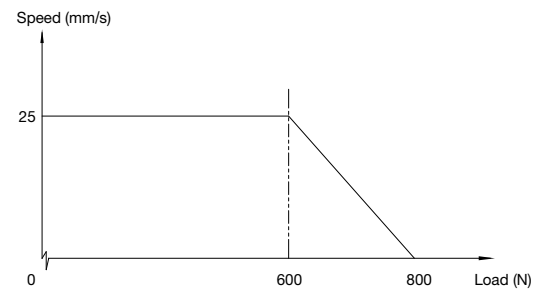

Technical specifications

Model	Load (N)	Noise (dB)	Typical Max speed 0 load~Rated load (mm/s)	Duty cycle	Stroke (mm)	Min. height (mm)
BBS35TS-S32S	600	≤50	25	10%	488	700



INVICTUS C

GAMING STANDING DESK SOLUTION
BBS35TS-S13S-409-0-0-B-06-0-0-JC

Features

- Max. Speed: 40mm/s
- Rated load: 1200N
- Noise: <50db
- Minimum height: 600mm
- Maximum height: 1250mm
- Control box: JCB36NE2P
- Handset: K23/K52C
- Motor: high-power motor by BIBUS
- Standard colors: black
- Weight: 66kg
- Max Loading quantity:
20GP: 56 SETS
40GP: 140 SETS

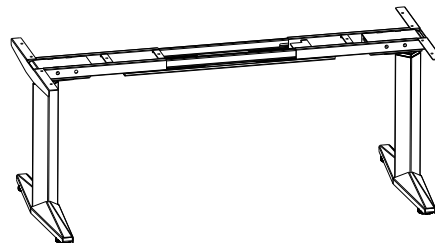
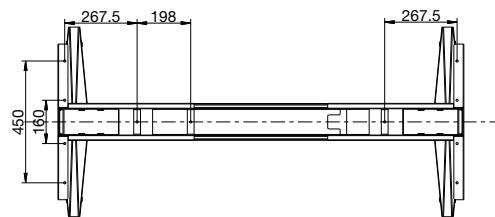
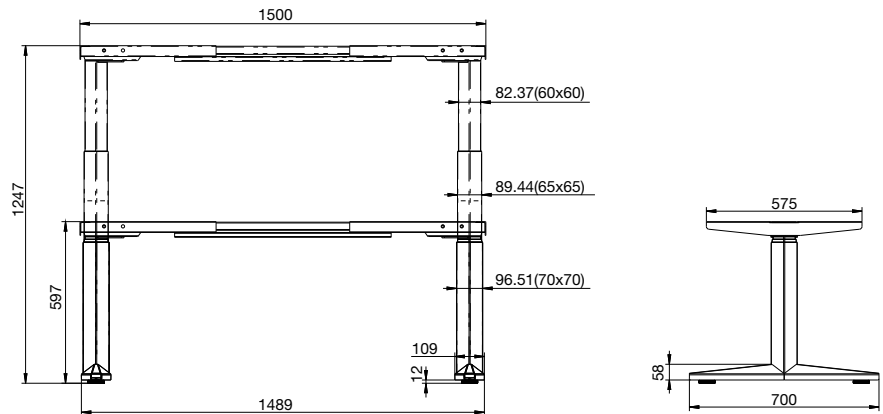

Technical specifications

Model	Load (N)	Noise (dB)	Typical Max speed 0 load~Rated load (mm/s)	Duty cycle	Stroke (mm)	Min. height (mm)
InvictusC	1200	<50	40	10%	650	600

KARMA ESSENCE

STANDING DESK

Features

- Rated load:1200N
- Max speed: 35mm/s
- Noise: <500B
- Maximum lateral force: 100N.m
- Standard mounting distance: 580mm
- Standard stroke: 650mm
- Outer tube dimensions: 70mm
- Motor: BIBUS high-power motor
- Surface: Powder coating, Standard color: white

Usages

- Working cycle: 10%; work for 1 minute and rest for 9 minutes.
- Usage environment: Indoor use only.
- Storage and transportation temperature: -10 °C ~ 70 °C



Dimensions

With tabletop

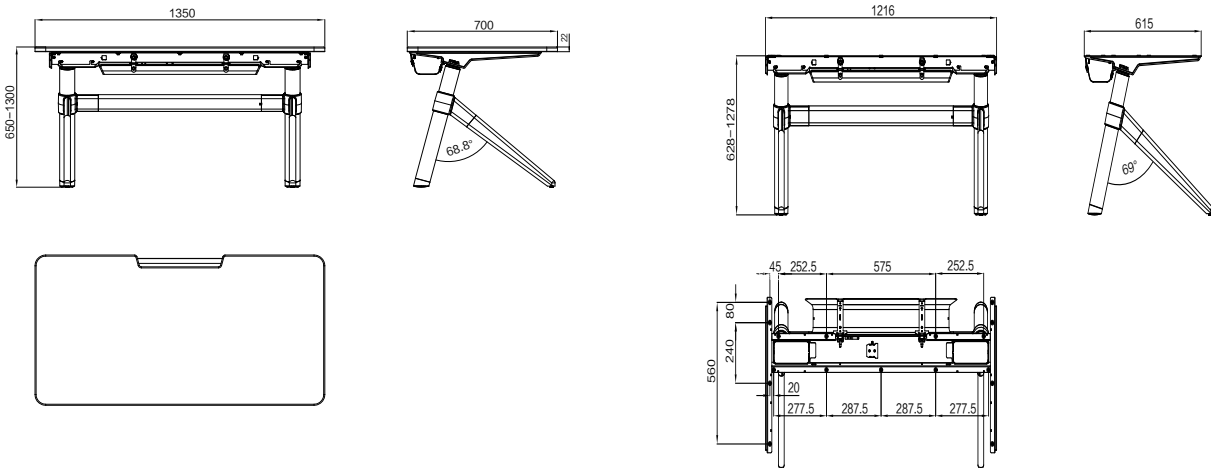

Model	Rated load (N)	Static loading (N)	Rated load current (A)	Maximum speed no load~rated load (mm/s)	Duty cycle	Stroke (mm)	Min. height (mm)
Karma Essence	1200	1200	5	35	10%	650	580

BBS35TF-DC2R

ODETTE 2.0 STANDING DESK SOLUTION

Features

- Rated load: 1000N
- Static loading: 2000N
- Max. speed: 32mm/s
- Noise: s 53dB
- Frame size: 1600X800mm(Do not stretch)
- Height Range: 670-1120mm
- Surface: powder-coating
- Standard colors: black

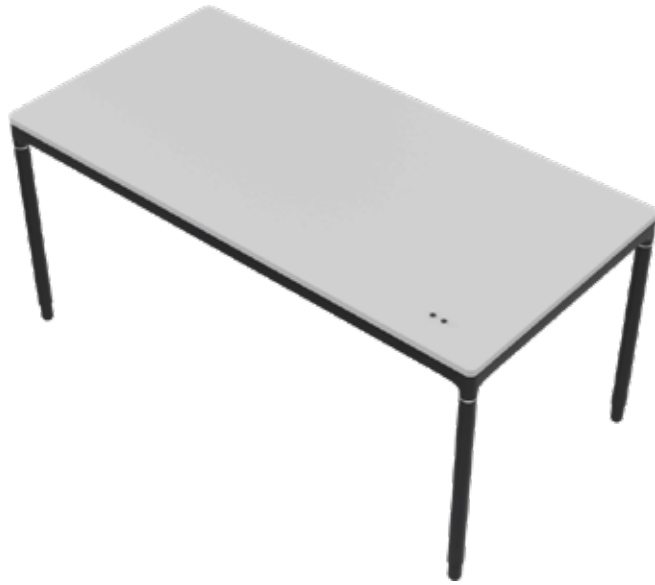

Dimensions

With tabletop

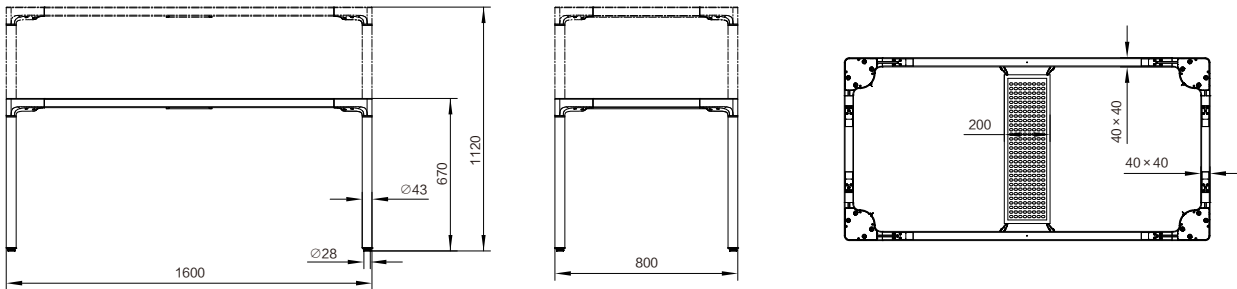

Model	Rated load (N)	Static loading (N)	Maximum speed no load~rated load (mm/s)	Duty cycle	Stroke (mm)	Min. height (mm)
Odette 2.0	1000	2000	32	20%	450	670

TO-ROSTRA 1.0 BBS35TO-ZR23S

SURFACE COLOR

Plastic spray, color can be customized

•Option

JCP35PA-B-3 lithium battery

TECHNICAL PARAMETER

 Height	(mm)	 Noise	(dB)
717 ~ 1117		≤50dB	
 Speed	(mm/s)	 Load Capacity	(N)
30		450	



Dimensions

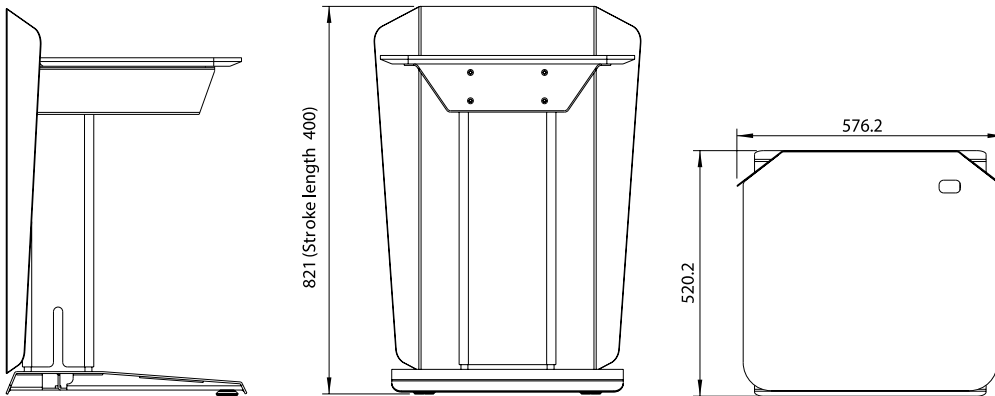

Technical specifications

Model	Rated load (N)	Static Self-locking (N)	Typical current at rated load (A)	Typical Max speed 0 load~Rated load (mm/s)	Duty cycle	Stroke length (mm)	Built-in length (mm)
Rostra1.0	450	1000	5.5	30	10%	400	717

TO-CLASSIC BBS35TO-S13S

SINGLE-MOTOR ADJUSTABLE DESKS

SURFACE COLOR

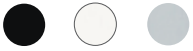

Black / White / Silver

•Option

The possibility of production with the given RAL code for high-volume orders

TECHNICAL PARAMETER

Height	(mm)	Noise	(dB)
585 ~ 1235		<50	
Speed	(mm/s)	Load Capacity	(N)
40		800	

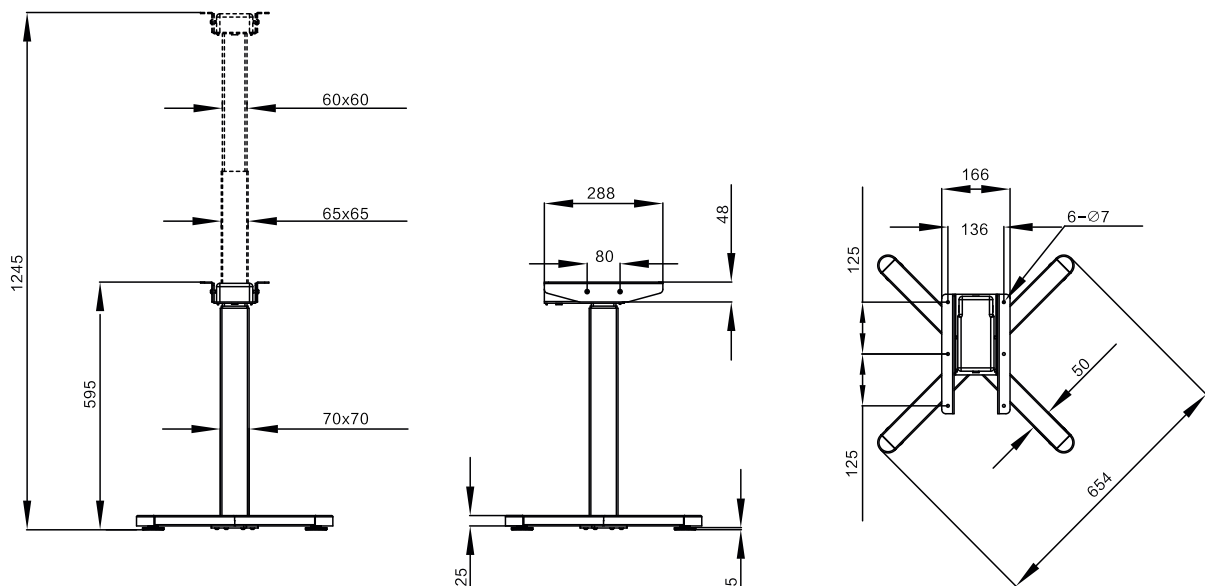



BBS37B1

ELECTRIC WALL CABINET LIFTING SYSTEM

Features

- Input voltage: 18VDC
- Max load: 500N
- Stroke length: 550±2mm, 650±2mm
- Retracted length: 670±3mm, 770±3mm
- Current at no-load: ≤2.0A
- Current at full load: ≤5.0A
- Speed at no-Load: 30±10% mm/s
- Speed at full load: 30±10% mm/s
- Hall sensor: Optional
- Color: White
- IP grade: IP43
- Noise level: ≤50dB (Ambient Noise ≤40dB)



Dimensions

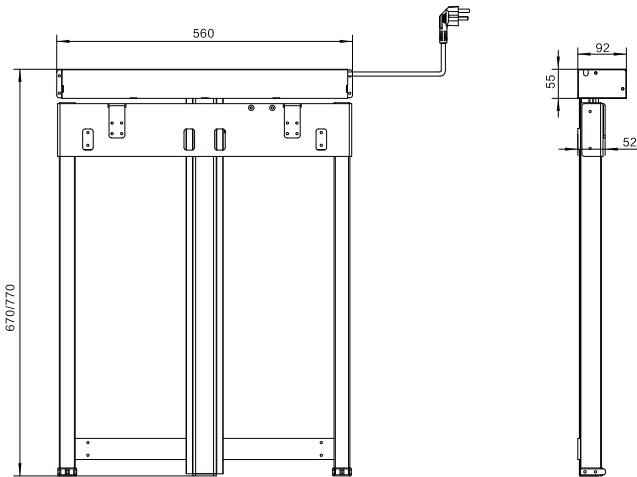

Characteristic Curve

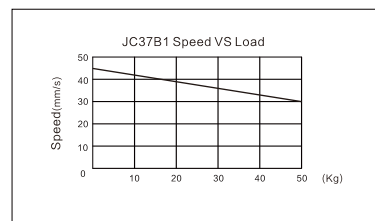
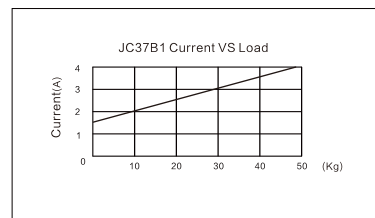

Ordering Key

BBS37B1 · Y - 0D5 - 30 - 18 - 655/770 - W - 10

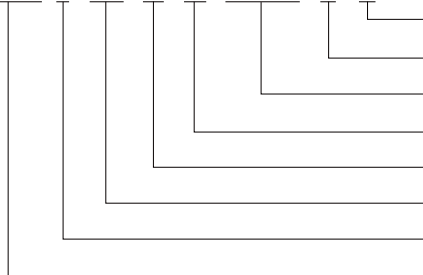

- | | |
|--------------------------|----------------------|
| Surface | Surface spray |
| Color | White |
| Stroke /Retracted Length | |
| Input Voltage | 18V |
| Speed at full load | 30=30mm/s |
| Load capacity | 0D5=500N |
| Optional feature | Y=Hall sensor option |
| Type | |



BBS35VT

TV LIFTING TYPE: 650/1000 MM



Dimensions

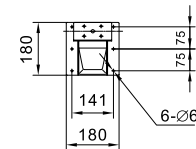
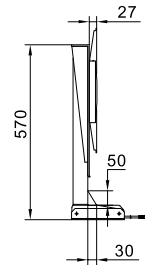
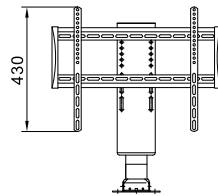
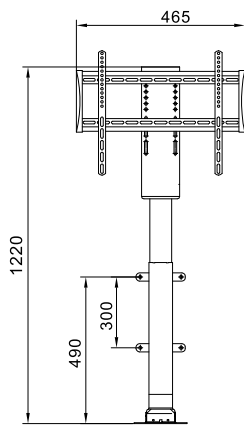

BBS35VT-650



BBS35VT-650
Stroke length(mm): 650
Retracted Length(mm): 570

BBS35VT-1000
Stroke length(mm): 1000
Retracted Length(mm): 810

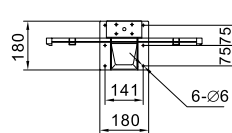
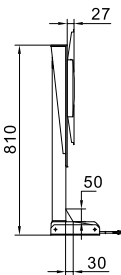
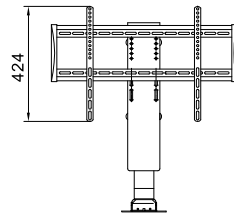
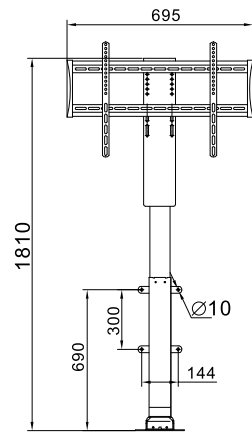

BBS35VT-1000



Matching Control Box: BBSB35Q

Ordering Key

BBS35VT - 3 - B - 230 (650)

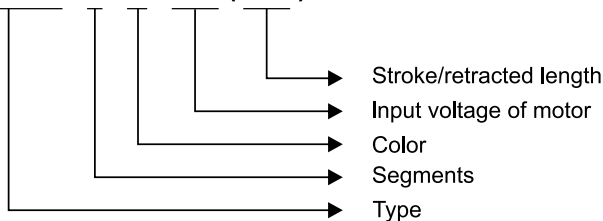



BBS35SZJ1

APPLICATION OF DRESSER LIFTING SYSTEM

Technical Specifications (Standard Value)

- Input voltage: 220VAC
- Rated power: 56W
- Max. push and pull force: 50KG (including cabinet)
- Max. stroke: 650mm
- Noise Level: ≤50dB
- Installation Length: 575mm
- Speed at no load: 25mm/s
- Speed at full load: 30mm/s
- Ambient temperature: -10°C ~ +70°C
- Relative humidity: 95% or less, non-condensing
- Control method: Wireless touch remote control
- Self-locking function: Yes
- Overload protection: Yes
- Protection class: IP44
- Descent anti-collision: Yes
- Packing size: 600x530x145mm
- Connection & Power Cord: 220VAC adapter and power cord
- Duty Cycle: 10%, max. continuous work for 2min. and 18 min. off



Dimensions

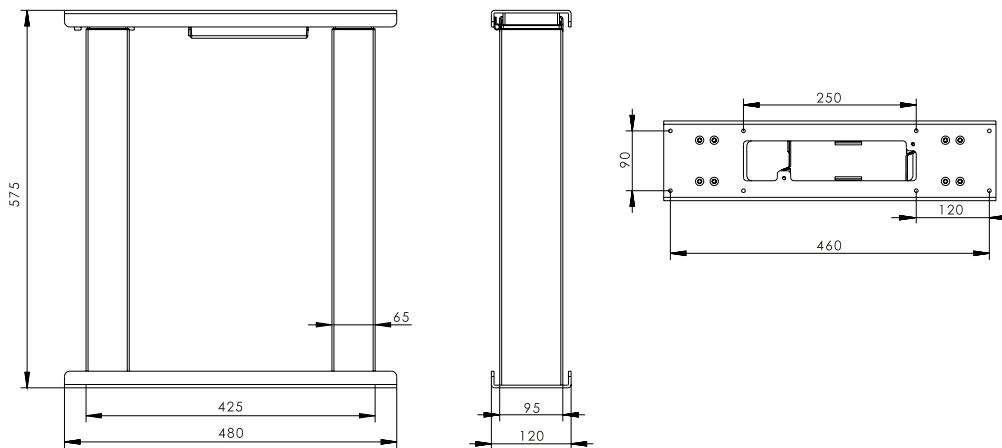

Ordering Key

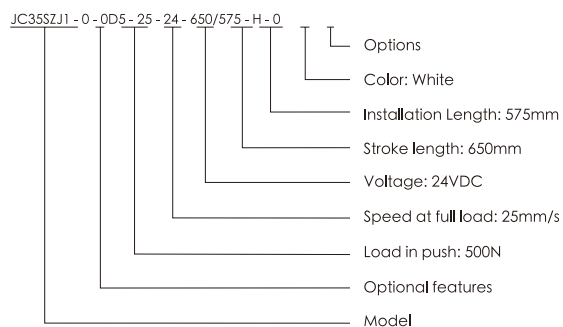

BIBUS C30 WIRELESS CHARGER

Features

- Compatibility with Qi-certified phones and headphones
- For iPhone series: iPhone 13/13 Pro/13 Pro Max/12/12 Pro/12 Pro Max/12 Mini/SE/11/11 Pro/11 Pro Max/X/ Xs/Xs Max/8/8 Plus
- For Samsung phones: Galaxy S20/S20+/S10/9/8/7 series, Note20 Ultra/Note20/Note10/9/8/7/5
- Easy charging
- Universal compatibility
- Charging distance of more than one inch
- Option to mount under the table or charge from the top of the table
- Easy installation
- Overcharge and heat protection
- Minimalist touch
- Time-saving

1.18 Inch Charging Distance

Charges through surfaces between 13-30mm (0.51"-1.18") with easy and safety.

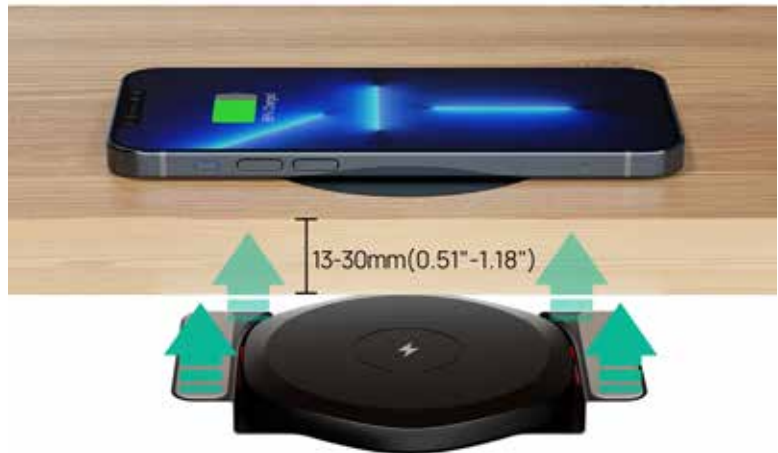

Works Through:



What You Get

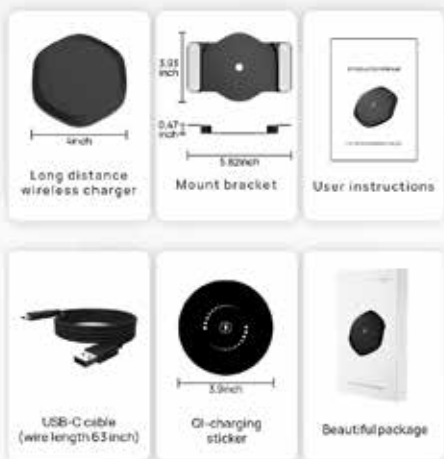

Superior Safety

Intelligent protection system guarantees that no harm will ever come to your device while charging it normally

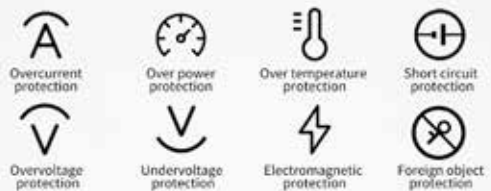

LOGICflex X

Features

- Unique leg shaping and design
- Clean, crisp design
- Intelligent System Protection
- 4 integrated sensors
- Brushless motor technology
- Plug & Play technology
- Simple & fast set up
- Compact & e-Commerce designed packaging
- Made in EU



White



Black

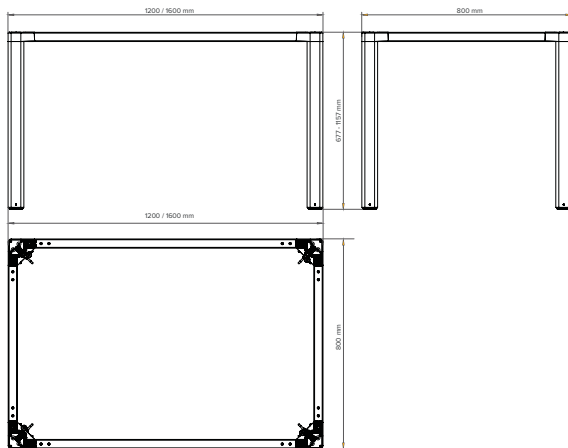

Frame size	1600 mm x 800 mm 1200 mm x 800 mm
Travel range (without tabletop)	677 mm (± 13 mm) to 1157 mm (± 13 mm)
Stroke	480 mm
Adjustment speed	38 mm/s (24 mm/s reduced speed)
Lifting capacity (without tabletop)	100 kg
Max. load	170 kg*
Input rating	220-240 VAC, 3,5 A
Duty cycle	2 min. ON / 18 min. OFF

Max. product weight	29,5 kg
Max. leg package weight	22,9 kg
Max. frame package weight	8 kg
Leg package dimensions (mm)	800 x 360 x 135
Frame package dimensions (mm)	1500 x 140 x 55 1370 x 140 x 55
Available Colors	Black non-structured, White non-structured
Ambient conditions during transport and storage	Temperature between -35°C and 80°C Temperature over 50°C only for periods not exceeding 72h Maximum relative humidity between 95% and 5% (lower allowed)
Ambient conditions during operation	+5°C to +40°C at max. 68% relative air humidity (non-condensing), up to an altitude of 2000 m.
Applied standards	EN ISO 12100 DIN EN ISO 13854 EN 60335-1 EN 527-1 EN 527-2 EN 62233 EN IEC 61000-6-1 EN 61000-6-3 EN 61000-3-2 EN 61000-3-3 ISO 13849-1 ISO 13849-2, PLB AIFPS GS 2019:01 - PAH

Order code

Example: LOGICflex-X1-EU-WHT-LDS-00
LOGICflex-Ao-BB-CCC-DDD-00



3/STAGE LIFTING COLUMN

TECHNICAL PARAMETER

 **Stroke** (mm)

650

 **Height** (mm)

560 ~ 1210

 **Load Capacity** (N)

800

 **Speed** (mm/s)

40

SURFACE COLOR



Black / White / Silver

•Option

The possibility of production with the given RAL code for high-volume orders

BBS36DR1-3-S

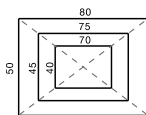

BBS36DR1-3-R

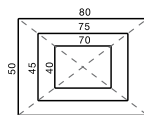

BBS36DR2-3-S

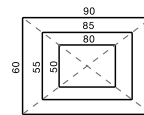

BBS36DR3-3-S

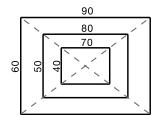

BBS36DS4-3-S

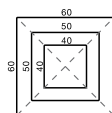

BBS36DS4-3-R

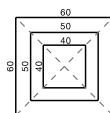

BBS36DS5-3-S

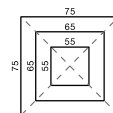

BBS36DS9-3-S

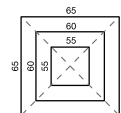

BBS36DR4-3-S

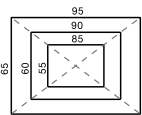

BBS36DR6-3-S

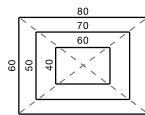

BBS36DS1-3-S

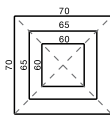

BBS36DS1-3-R

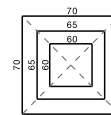
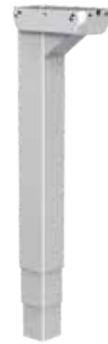

BBS36DS3-3-S

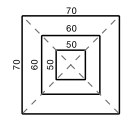

BBS36DC1-3-S

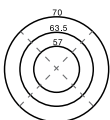

BBS36DC1-3-R

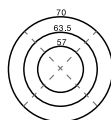

BBS36DE1-3-S

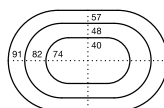



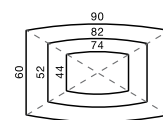

BBS36DE2-3-S



2/STAGE LIFTING COLUMN

TECHNICAL PARAMETER

 Stroke	(mm)
500	
 Height	(mm)
650 ~ 1150	
 Load Capacity	(N)
800	
 Speed	(mm/s)
32	

BBS36DR1-2-S

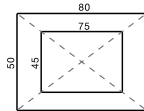

BBS36DR1-2-R

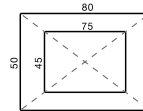

BBS36DS5-2-S

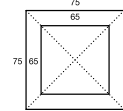

SURFACE COLOR

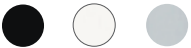

Black / White / Silver

•Option

The possibility of production with the given RAL code for high-volume orders

BBS36DS9-2-S

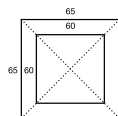

BBS36DC1-2-S

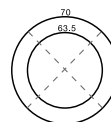

BBS36DE1-2-S

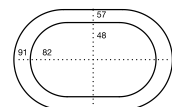

OTHER LIFTING COLUMN

SURFACE COLOR



Black / White / Silver

•Option

The possibility of production with the given RAL code for high-volume orders

BBS36ZR4-3-S



TECHNICAL PARAMETER

Stroke (mm)

660

Height (mm)

518~ 1178

Load Capacity (N)

800

Section size (mm)

55x85 / 60x90 / 65x95

Speed (mm/s)

40

BBS35EN-2K



TECHNICAL PARAMETER

Stroke (mm)

400

Height (mm)

650~ 1050

Load Capacity (N)

1500

Bending moment (NM)

dynamic: 500N / static: 1000

Speed (mm/s)

30

Section size (mm)

145x112 / 164x131

BBS35EA-3A



TECHNICAL PARAMETER

Stroke (mm)

350

Height (mm)

325~ 675

Load Capacity (N)

2000

Bending moment (NM)

dynamic: 250N / static: 500

Speed (mm/s)

16

Section size (mm)

175x140

SURFACE COLOR



Black / White / Silver

•Option

The possibility of production with the given RAL code for high-volume orders

OTHER LIFTING COLUMN

BBS36ZS8-3-S



TECHNICAL PARAMETER

Stroke (mm)	Load Capacity (N)	Speed (mm/s)
650	800	40
Height (mm)	Section size (mm)	
560~ 1210	70x70 / 65x65 / 60x60	

BBS36H2



TECHNICAL PARAMETER

Stroke (mm)	Load Capacity (N)	Speed (mm/s)
500	500	30
Height (mm)		
860		

SURFACE COLOR

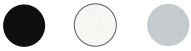

Black / White / Silver

•Option

The possibility of production with the given RAL code for high-volume orders



TECHNICAL PARAMETER

	Stroke	(mm)
650		
	Height	(mm)
560~ 1210		

	Load Capacity	(N)
800		
	Section size	(mm)
40x70 / 45x75 / 80x80		
	Speed	(mm/s)
40		

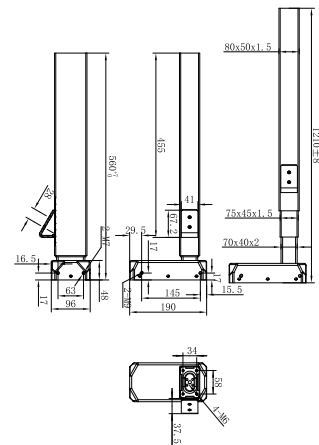

TECHNICAL PARAMETER

	Stroke	(mm)
550		
	Height	(mm)
650~1150		

	Load Capacity	(N)
800		
	Section size	(mm)
75x45 / 80*50		
	Speed	(mm/s)
32		

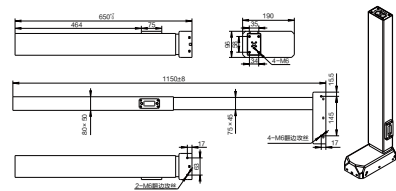

CONTROL BOX



BBS35N1



BBS35N2



BBS35N3



BBS35N4



BBS35NS1



BBS35NS2



BBS35N2C



BBS35M

CONTROL BOX + HANDSET



BBS35M1



BBS35M3



BBS35M6



BBS35M11C



BBS35M12B



BBS35M12C

HANDSET



BBSHT35K

- 4 Memory Buttons
- Black
- LED



BBSHT35K9

- 4 Memory Buttons
- Black
- LED
- USB Charger



BBSHT35K11

- 3 Memory Buttons
- Water-proof on the Front Side
- Silicone Button
- 90° mounting angle
- Black / White / Grey / Green



BBSHT35K24A

- Up & Down Button
- Seesaw Button



BBSHT35K24B

- Up & Down Button
- Seesaw Button
- LED



BBSHT35K24C

- 3 Memory Buttons
- Seesaw Button
- LED
- USB Charger



BBSHT35K24D

- 3 Memory Buttons
- Seesaw Button
- LED
- Two Speed
- USB Charger



BBSHT35K24S

- 3 Memory Buttons
- Seesaw Button
- LED
- Two Speed
- USB Charger
- Bluetooth



BBSHT35K23

- 2 Memory Buttons
- Acrylic Material
- With different back light color options
- Sedentary Reminder
- OLED

HANDSET



BBSHT35K26A

- Up & Down Button
- Top Mounted
- Multiple colors
- Silicone Button



BBSHT35K26B

- Up & Down Button
- Top Mounted
- Multiple colors
- LED
- Silicone Button



BBSHT35K26C

- 3 Memory Buttons
- Top Mounted
- Multiple colors
- LED
- Silicone Button



BBSHT35K26A

- Up & Down Button
- Side Mounted
- Multiple colors
- Silicone Button



BBSHT35K26B

- Up & Down Button
- Side Mounted
- Multiple colors
- LED
- Silicone Button



BBSHT35K22

- 3 Memory Buttons
- Water-proof on the Front Side
- Silicone Button
- 34° mounting angle
- Black / White / Grey / Green



BBSHT35K40C

- 4 Memory Buttons
- Side Mounted
- LED
- Silicone Button



BBSHT35K55C

- 4 Memory Buttons
- Side Mounted
- LED
- Silicone Button



BBSHT35K20

- Operate by tilting for up and down
- Acrylic Material
- With different back light color options
- Shapes can be customized

HANDSET



BBSHT35K50A

- Operate by tilting for up and down
- Indicator lights



BBSHT35K50B

- Operate by tilting for up and down
- LED



BBSHT35K50C

- 2 Memory locations
- Operate by tilting for up and down
- OLED
- Sedentary Reminder
- Child lock function



BBSHT35K52C

- 2 Memory Buttons
- LED
- DIY keyboard keys
- Light adjustment



BBSHT35M13

- 3 Memory Buttons
- Touch Screen
- LED
- 34° or 90° mounting angle



BBSHT35L

- Up & Down Button
- Black



BBSHT35M6

- 3 Memory Buttons
- Touch Screen
- OLED
- Operate by rotating for up and down
- Sedentary Reminder



BBSHT35M33A

- Made of leather
- Up & Down Button



BBSHT35M33C

- Made of leather
- Up & Down Button
- 2 Memory locations

HANDSET



BBSHT35K32C

- 3 Memory Buttons
- Water-proof on the Front Side
- Silicone Button
- LED



BBSHT35K33C

- 3 Memory Buttons
- Water-proof on the Front Side
- Silicone Button
- LED



BBSHT35M18C

- 3 Memory Buttons
- Water-proof on the Front Side
- Touch Screen
- Light Wake
- LED



BBSHT35M19C

- 3 Memory Buttons
- Water-proof on the Front Side
- Touch Screen
- Light Wake
- LED



BBSHT35K10

- Up/down drive
- Silica gel buttons, waterproof front side
- Wire length: 2000mm with
- 8-core crystal plug



BBSHT35M9

- Up&Down button
- Top mounted
- Customized colours

ACCESSORIES

FAST CHARGER



BBSB35N7

- Maximum output power: 65W
- Has TypeA and TypeC charging ports

2.4G WIRELESS ADAPTER



BBSP35N-2.4G

- Input power: 5V
- Remote control frequency: 2.4GHz
- Transmission distance: 8M

LITHIUM BATTERY



BBSP35PA-B-3

- Mobile office
- Low power consumption
- USB charger
- Safe & fast charging

BLUETOOTH ADAPTER



BBSP35N-BLT

- Plug in the Bluetooth receiver box on the control box, then turn on the Bluetooth and control the adjustable table through the APP on mobile phone

CABLE CHAIN



BBS-TSXG01

- Accessories of standing desk for cable management.
- Size: 90mm*120mm*1400mm
- Color: Black, White, Chroma
- Material: ABS (Black/White) / PP (Chroma)

WIFI ADAPTER



BBSP35N-Wifi

- Plug in the Bluetooth receiver box on the control box, then turn on the Bluetooth and control the adjustable table through the APP on mobile phone

SIX AXIS SENSOR



BBSB35N-6AXIS

- Intelligent anti-collision accessories
- High sensitivity, stable operation

WIRELESS CHARGER



BBSP35WA-A

- Power the phone wirelessly
- Under the desktop

Workstation Reservation Box



BBSP35NA

- It is used in the station reservation system which can realize functions such as non-sensing check-in, NFC check-in, light prompt, etc.

ACTUATORS



BBS35N

- Max load capacity(N):20
- Max speed at load(mm/s):12
- Max IP grade:IPX4



BBS35N1

- Max load capacity(N):100
- Max speed at load(mm/s):7
- Max IP grade:IPX4



BBS35N3

- Max load capacity(N):100
- Max speed at load(mm/s):5
- Max IP grade:IPX4



BBS35L

- Max load capacity(N):4000
- Max speed at load(mm/s):30
- Max IP grade:IPX4



BBS35J1

- Max load capacity(N):2000
- Max speed at load(mm/s):14,5
- Max IP grade:IPX4



BBS35W1

- Max load capacity(N):1000
- Max speed at load(mm/s):20
- Max IP grade:IPX4



BBS35W2

- Max load capacity(N):3000
- Max speed at load(mm/s):16
- Max IP grade:IPX4



BBS35W2-2

- Max load capacity(N):3000
- Max speed at load(mm/s):16
- Max IP grade:IPX6

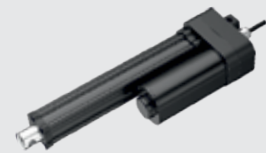

BBS35W5

- Max load capacity(N):3000
- Max speed at load(mm/s):11
- Max IP grade:IPX8

ACTUATORS



BBS35N6

- Max load capacity(N):1200
- Max speed at load(mm/s):10,5
- Max IP grade:IPX6



BBS35N8

- Max load capacity(N):2500
- Max speed at load(mm/s):9,6
- Max IP grade:IPX6



BBS35L6

- Max load capacity(N):2000
- Max speed at load(mm/s):63
- Max IP grade:IPX4



BBS35L19-A

- Max load capacity(N):100
- Max speed at load(mm/s):9
- Max IP grade:IPX4



BBS35L19-B

- Max load capacity(N):100
- Max speed at load(mm/s):9
- Max IP grade:IPX4



BBS35L19-C

- Max load capacity(N):100
- Max speed at load(mm/s):9
- Max IP grade:IPX4



BBS35TM2

- Max load capacity(N):1000
- Max speed at load(mm/s):14
- Max IP grade:IPX4



BBS35ESN-2 ~ BBS35ES-2

- Max load capacity(N):1000 ~ 6000
- Max speed at load(mm/s):11 ~ 21
- Max IP grade:IPX4



BBS37B1

- Max load capacity(N):500
- Max speed at load(mm/s):30
- Max IP grade:IPX4

TTM lifting

Keep Sitting Comfortable by Adjustable Height

Features

- Optimized design, the profiles are much more smooth of senses.
- Surface dealing of electrophoresis technology, with a sense of intelligence.
- Compact structure shows finest industrial aesthetics, smaller installing dimensions makes a sensitive motion.
- Safe and sound after international rollover resistance tests. A great choice for many applications.



Matching Control Box: BBSB35Q



Optional Matching: BBSHR35F





CONTROL SYSTEM

START A HEALTHY OFFICES STATE, MAKE YOUR LIFE FULL OF POSSIBILITIES

Up & Down control / Sit & Stand reminder / Office data statistics
used in mobile and computer



AIDESK Control System

- Control UP & DOWN by mobile phone
- Applicable for android and IOS system
- Sedentary reminder function



AIWORKING Desk Control Software

- Control by computer software
- Display the height
- Show the standing-time and calorie-burning results
- To memory the height of standing and sitting
- Statistical datas and health management

BIBUS Teknoloji | Satış Ağımız

Genel Merkez

Switzerland
BIBUS AG
Allmendstrasse 26
8320 FEHRALTORF
Tel. +41 44 877 50 11
Fax +41 44 877 50 19
E-Mail info.bag@bibus.ch
www.bibus.ch

Switzerland
BIBUS HYDRAULIK AG
Allmendstrasse 26
8320 FEHRALTORF
Tel. +41 44 877 52 11
Fax +41 44 877 52 19
E-Mail bibushydraulik@bibus.ch
www.bibushydraulik.ch

Dünya'da BIBUS

Austria
BIBUS Austria Ges.m.b.H.
Eduard Klinger-Straße 12
A-3423 St. Andrä-Wördern
Tel. +43 2242 333 88
Fax +43 2242 333 88 10
E-mail info@bibus.at
www.bibus.at

Latvia
BIBUS Baltics SIA
Kleistu iela 24
LV-1067 RIGA
Tel. +371 6763 05 01
Fax +371 6763 05 01
E-mail info@bibusbaltics.eu
www.bibusbaltics.eu

Belarus
BIBUS cooo
8th Per. Ilyicha 13a, office 2.1
246013 GOMEL
Tel. +375 232 29 31 39
Fax +375 232 29 72 05
E-mail info@bibus.by
www.bibus.by

Bosnia
BIBUS doo
Karadordeva bb BA 76311
Dvorovi-Bijeljina Hercegovina
Tel. +387 55 423 444
Fax +387 55 423 444
E-mail info@bibus.ba
www.bibus.ba

Slovenia
INOTEH d.o.o.
K železnici 7
SI-2345 Bistrica ob Dravi
Tel. +386 2 665 11 31
Fax +386 2 665 20 81
E-mail info@inoteh.si
www.inoteh.si

China
BIBUS Shanghai Mec. Ltd.
2nd Floor, Block 9, No. 188
Shanfeng Road 201508
Tel. +86 21 5803 9270
Fax +86 21 6729 8667
E-mail info@bibuschina.cn
www.bibuschina.cn

Croatia
BIBUS Zagreb d.o.o.
Kovinska 28
HR-10090
ZAGREB - SUSEDGRAD
Tel. +385 1 3818 004
Fax +385 1 3818 005
E-mail bibus@bibus.hr
www.bibus.hr

Czech Republic
BIBUS s.r.o.
Videňská 125
619 00 BRNO
Tel. +420 547 125 300
Fax +420 547 125 310
E-mail bibus@bibus.cz
www.bibus.cz

Denmark
BIBUS Sindby A/S
Edisonvej 11
7100 Vejle
Tel. +45 75 88 21 22
Fax +45 75 88 21 21
E-mail bibus@bibus.dk
www.bibus-sindby.dk

France
BIBUS France S.A.S.
ZA du Chapotin Sud
233, rue des Frères Voisin
69970 CHAPONNAY
Tel. +33 4 78 96 80 00
Fax +33 4 78 96 80 01
E-mail contact@bibusfrance.fr
www.bibusfrance.fr

India
BIBUS India Pvt Ltd.
Yellupura Village, Kasaba Hobli,
Near KSSIDC Industrial Area,
Doddaballapura Taluk No.102/25,
1st Floor, Bangalore - 561203.
Tel. +91-953 802 78 82
E-mail info@bibus.in
www.bibus.in

Germany
SAUER BIBUS GmbH
Lise-Meitner-Ring 13
89231 NEU-ULM
Tel. +49 731 1896 0
Fax +49 731 1896 199
E-mail info@sauerbibus.de
www.sauerbibus.de

Germany
WESER-PUMPEN GmbH
Güterstrasse 10
27777 Ganderkesee
Tel. +49 4222 947 510 0
Fax +49 4222 947 510 10
E-mail info@weser-pumpen.de
www.weser-pumpen.de

Netherlands
BIBUS Romicon B.V.
Vlijtweg 10A
8191 JP Wapenveld
Tel. +31 38 447 91 81
E-mail info@bibusromicon.nl
www.bibusromicon.nl

Hungary
BIBUS Kft.
Almás kert út 9.
2220 VECSÉS
Tel. +36 29 557 764
Fax +36 29 557 777
E-mail info@bibus.hu
www.bibus.hu

Italy
BIBUS Italia Srl
Via Robert Fulton, 27
San Giovanni in Persiceto (BO)
40017 C.F. e P.IVA n. 03248661203
Tel. +39 051 893958
Fax +39 051 780081
E-mail info@bibus.it
www.bibus.it

Bulgaria
BIBUS Bulgaria Ltd.
2 Blvd. Prof. Tzvetan Lazarov,
Floor 2, 1574 SOFIA
Tel. +359 2 971 98 08
Fax +359 2 927 32 64
E-mail info@bibus.bg
www.bibus.bg

Malaysia
BIBUS Malaysia Sdn. Bhd.
7, Jalan Kartunis, U1/47,
Glenmarie Temasya Industrial Park
40150, Shah Alam, Selangor
Tel. +60 3 5569 70 77
Fax +60 3 5569 70 66
Email info@bibus.my
www.bibus.my

Great Britain
BIBUS (UK) Ltd
Unit 20-21 Soho Mills
WOOBURN GREEN
Bucks HP10 0PF
Tel. +44 1628 533 300
Fax +44 1628 533 377
Email info@bibus.uk
www.bibus.uk

Poland
BIBUS Menos Sp. z o.o.
ul. Spadochroniarzy 18
80-298 Gdańsk
Tel. +48 58 660 95 70
Fax +48 58 661 71 32
E-mail info@bibusmenos.pl
www.bibusmenos.pl

Portugal
BIBUS Portugal, Lda
Centro Empresarial AAA
Rua Ponte da Pedra, 240 - C4
4470-108 Guelfães-Maia
Tel. +351 22 906 50 50
Fax +351 96 501 00 41
E-mail info@bibus.pt
www.bibus.pt

Romania
BIBUS Ses Srl
134/1 Calea Lugojului
307200 GHIRODA, TIMIS
Tel. +40 256 200 500
Fax +40 356 446 660
E-mail office@bibus.ro
www.bibus.ro

Russia
BIBUS o.o.o.
Zemskaya street 94
198205 ST. PETERSBURG
Tel. +7 800 100 14 52
Fax +7 812 309 41 51
E-mail info@bibus.ru
www.bibus.ru

Slovakia
BIBUS SK s.r.o.
Trnavska 31
949 01 NITRA
Tel. +421 37 777 79 11
Fax +421 37 777 79 19
E-mail sale@bibus.sk
www.bibus.sk

Germany
BIBUS GmbH
Max-Eyth-Straße 41/1
89231 NEU-ULM
Tel. +49 731 20 76 90
Faks +49 731 20 76 96 20
E-mail info@bibus.de
www.bibus.de

Spain
BIBUS Spain, S.L.
Rua do Arroncal, Vial C - Nave 4A
Parque Empresarial Porto do Molle
36350 NIGRAN (Pontevedra)
Tel. +34 986 24 72 86
Fax +34 986 20 92 47
E-mail info@bibus.es
www.bibus.es

Thailand
BIBUS Thailand
181/68 Soi Nuanchan 32
Nuanchan Buengkhum District
Bangkok 10230
Tel. +66 90 894 98 67
Fax +66 2 054 65 76
Email info@bibus.co.th
www.bibus.co.th

Switzerland
BIBUS Hydraulik AG
Allmendstrasse 26
8320 FEHRALTORF
Tel. +41 44 877 52 11
Fax +41 44 877 52 19
E-Mail bibushydraulik@bibus.ch
www.bibushydraulik.ch

Türkiye
BIBUS Endüstriyel A.Ş.
Osmangazi Mh. 3121 Sk.
No:5 Esenyurt/İstanbul
Tel. +90 212 293 82 00
Fax +90 212 249 88 34
E-mail info@bibus.com.tr
www.bibus.com.tr

Türkiye
BIBUS Hidrotos A.Ş.
Ostim OSB 1233. Cd. No:149
Yenimahalle/Ankara
Tel. +90 312 354 29 27
Fax +90 312 354 91 61
E-mail info@bibushidrotos.com.tr
www.bibushidrotos.com.tr

Ukrainie
BIBUS Ukraine TOV
Soborna st., 118the village of
Sofiyivska Borschagivka
Kiev region 08147
Tel. +380 44 545 44 04
Fax +380 44 545 54 83
E-mail info@bibus.ua
www.bibus.ua

Vietnam
BIBUS Vietnam Technology Co., Ltd.
No. 10, Lot K, Hoang Quoc Viet street
Phu My Ward, District 7, Ho Chi Minh City,
Tel. +84 28 3785 0627
Fax +84 8 378 506 28
E-mail info@bibus.vn
www.bibus.vn

BIBUS ENDÜSTRİYEL A.Ş.

Osmangazi Mh. 3121 Sk.
No:5 Esenyurt/İstanbul

Tel. +90 212 293 82 00

info@bibus.com.tr
www.bibus.com.tr

