



ROSTA INSIDE RECYCLING

Solutions for Increased Productivity & Output



THE CORE OF OUR EXCELLENCE

One Smart Concept, Endless Applications

It all started in 1944 with a clever invention. Today, ROSTA is the world's leading manufacturer when it comes to rubber spring, tensioning and damping solutions.

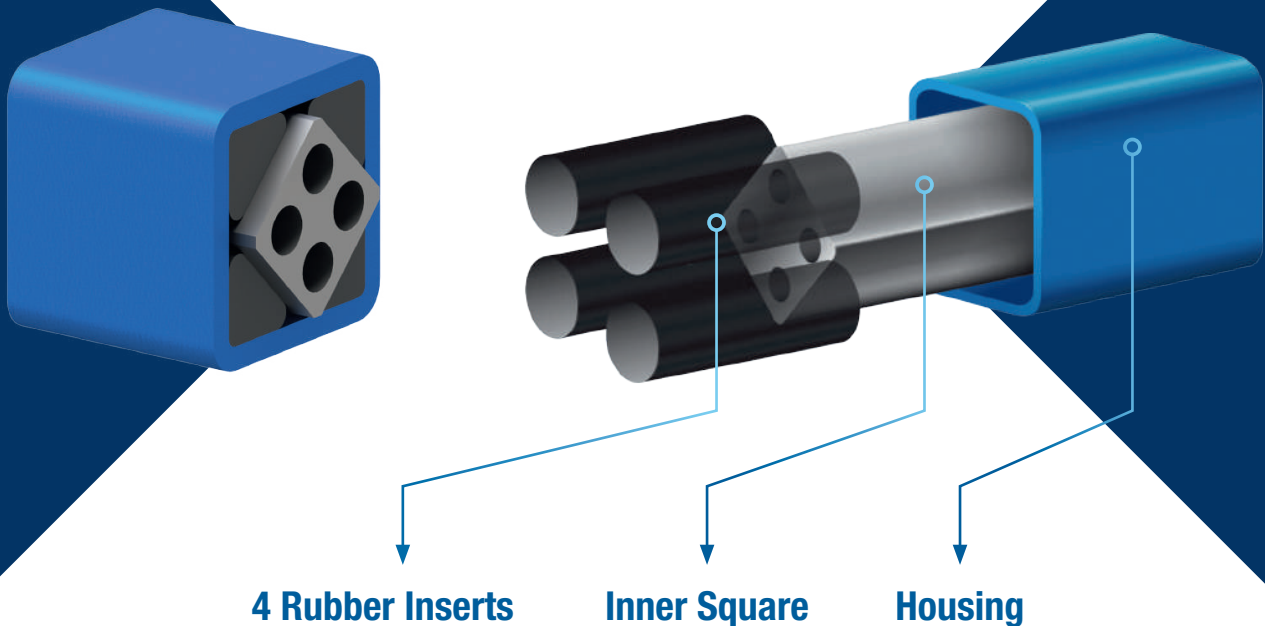

The ROSTA Element, an elastomer powered torsional spring, is central to our range of specialised machine components designed to provide a combination of useful functions.

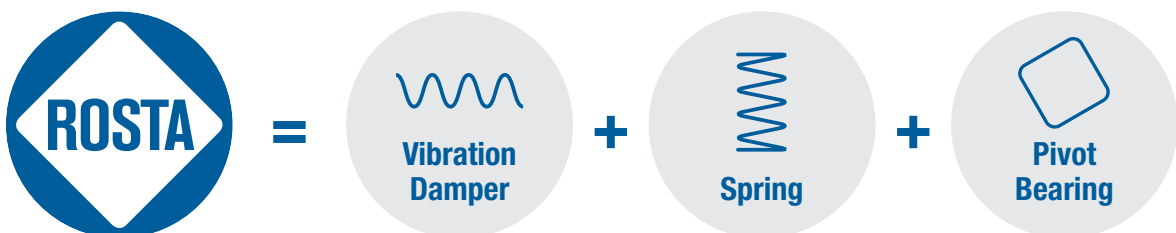

WHY WORK WITH ROSTA

Efficiency & Productivity

- Increased Productivity
- Smooth Operations
- Quality Materials

Lower Total Costs

- Longer Service Life
- Maintenance-Free Operation
- Simple, Durable & Noiseless



**CUSTOMER
VALUE-ADD**

Service & Aftersales

- Global Presence
- 24/7 Support
- High Stock Level

Flexibility & Customization

- Control Linear & Rotary Motion
- Torsional Elastomer Spring Solutions
- Customized Engineered Solutions
- Digital Services and Engineering

Swiss made 

Just trust Swiss excellence in engineering. Because your success is our ultimate goal. **Feel free to talk to us!**



ROSTA INSIDE RECYCLING

At ROSTA, we have developed a tailored process flow that reflects our expertise and understanding of the recycling industry. It is a complex industry where both open-loop and closed-loop processes are of great importance.

- Open-loop is converting manufactured goods into new raw materials and waste products
→ delaying disposal
- Closed-loop is recycling of manufactured goods back into itself or a similar product
→ no significant degradation or waste

Our ROSTA solutions play significant role in optimizing the productivity of machines within these recycling processes. Our components not only increase output, but they also help to conserve resources. Be smart put ROSTA INSIDE!

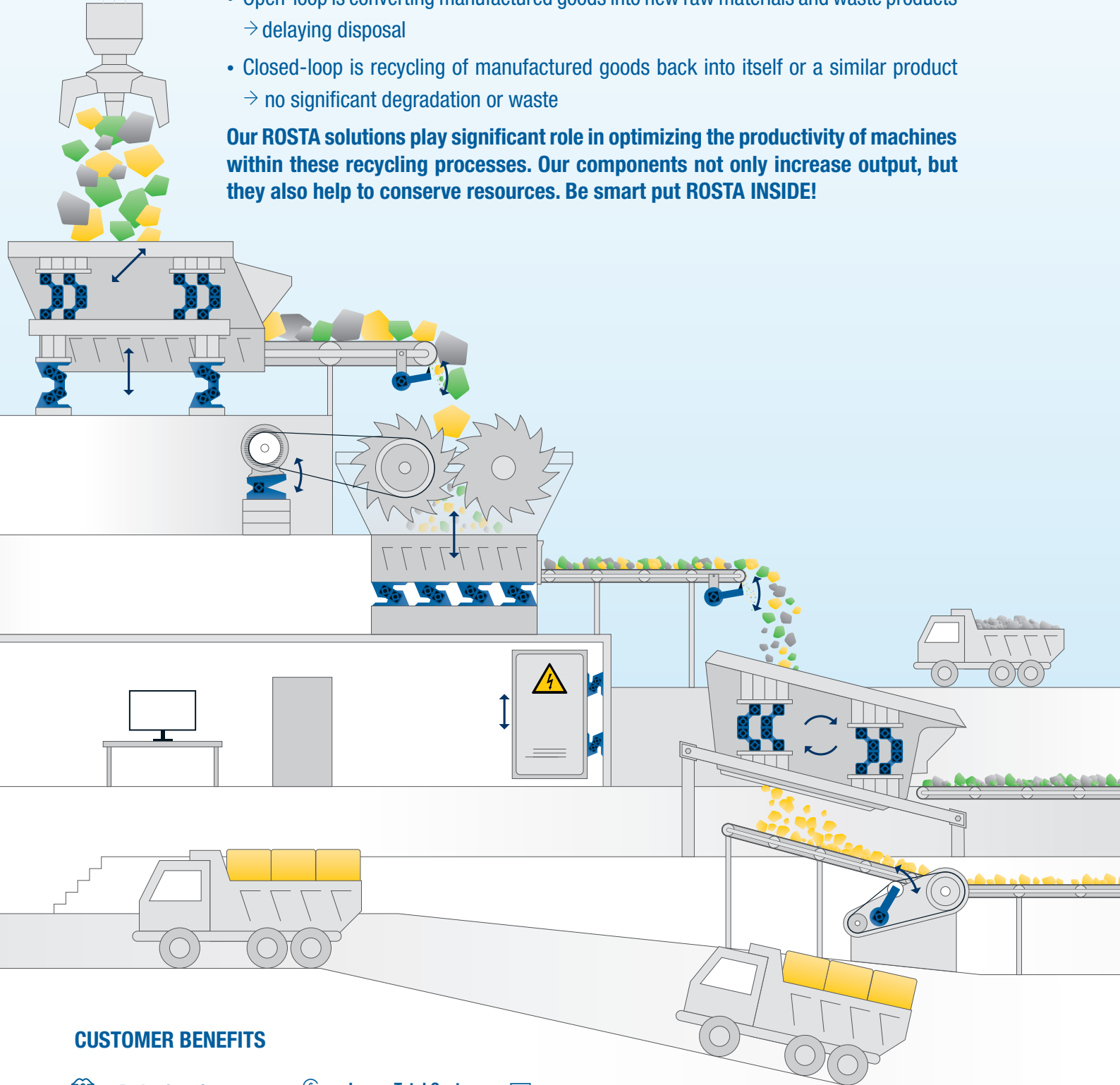

CUSTOMER BENEFITS



Reduction of
Noise & Vibration



Lower Total Cost
of Ownership



Long Life Cycle



Maintenance Free



Safe for User



Tearproof

BELT CONVEYORS 4

- Belt Scrapers
- Belt Drives
- Chain Drives
- Impact Tables

FREE OSCILLATING SYSTEMS 8

- Feeders
- Screens (Linear & Circular)
- Spiral Conveyors
- Hanging Systems
- Mobile Screens

CRUSHERS & SHREDDERS 6

- Belt Transmissions
- Shock Absorbers

GUIDED SYSTEMS 12

- One Mass Shaker Systems
- One Mass Shaker
“Natural Frequency” Systems
- Two Mass Shaker Systems

SEPARATORS 14

- Gyrotory Sifters
- Flip Flows
- Ballistic Separators
- Densimetric Tables

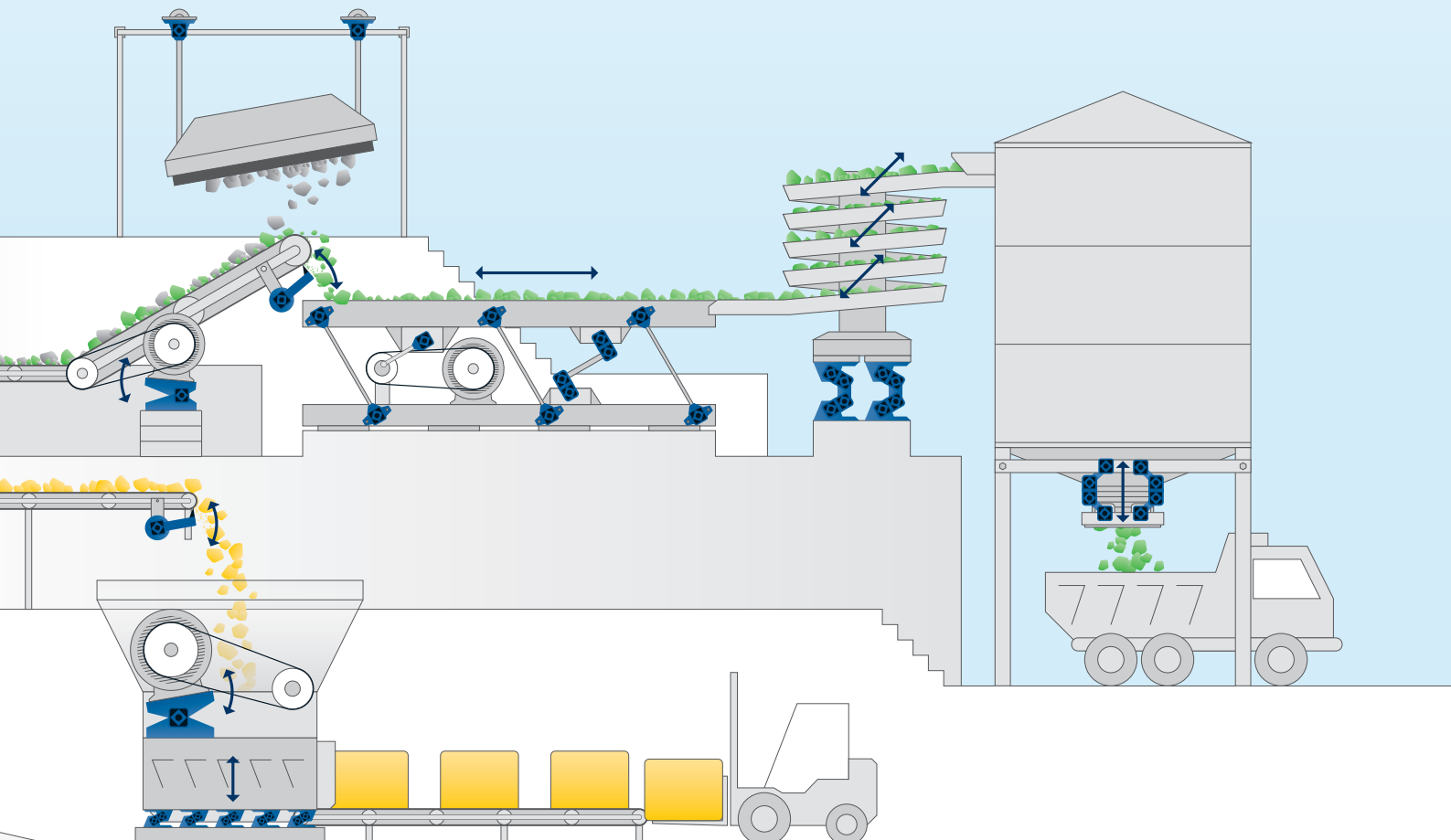

ROSTA INSIDE

BELT CONVEYORS

Belt conveyors play a crucial role in any recycling process because they enable the transportation of large quantities and heavy loads of waste products from the loading dock to the sorting line, up to the crushing area. **ROSTA supports running the conveyor smoothly and consistently, no matter what type you are using. Our components simplify and optimize the transport of recycling materials on the belt. This minimizes damage to the conveyor and improves output.**

CUSTOMER BENEFITS



Maintenance Free



Safe for User



Reduction of
Noise & Vibration



Long Life Cycle

BELT SCRAPERS



Dynamic Tensioner Devices: **SE Tensioners**



- Continuous / even belt surface engagement
- Automatically compensates for belt and blade wear
- Dampens shocks and overloads

Rubber Suspension Units: **DR / DK**



- Without lever arm – enables ROSTA technology to be adapted to the machine (or customer) design
- Continuous / even belt surface engagement
- Automatically compensates for belt and blade wear
- Dampens shocks and overloads

BELT DRIVES



Dynamic Tensioner Devices: **MB Motorbase**



- Fast and safe belt change, no realignment required
- Compensation of high start-up torque
- Constant transmission
- Better drive performance
- Energy cost savings
- Also available in ATEX specifications

CHAIN DRIVES

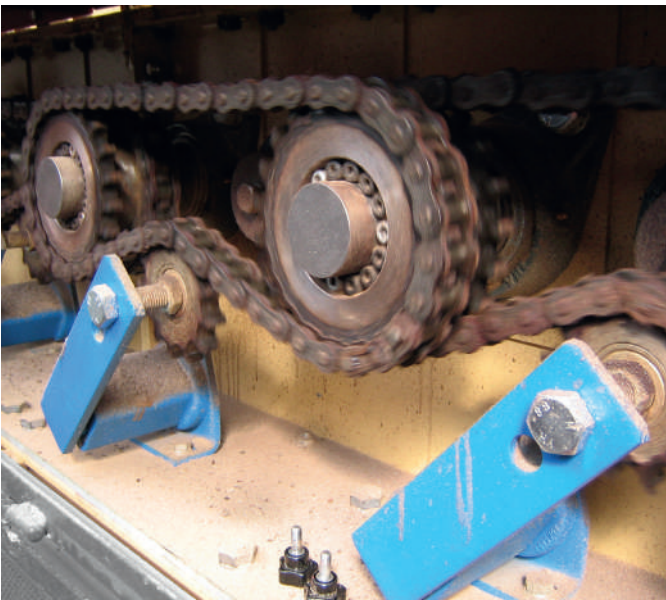

Dynamic Tensioner Devices: **SE Tensioners**



- Self-adjusting drive tensioner – set it and forget it!
- Increased drive performance
- Reduces wear and tear on ancillary drive components

IMPACT TABLES



Anti-Vibration Mounts: **ESL**



- Low frequencies and a high damping effect
- Good isolation of impacts and vibrations (High absorption of reactive forces)
- Suspensions of transfer cradles offering conveyor belt protection
- Absorbing solid-borne noise

ROSTA INSIDE

CRUSHERS & SHREDDERS

Only with their enormous forces can the most diverse materials be broken down into parts for further processing. **ROSTA components help to reduce maintenance time and minimize excessive vibrations and shocks.**

CUSTOMER BENEFITS



Maintenance Free



Long Life Cycle
(MTBF)



Reduction of
Noise & Vibration



Lower Total Cost
of Ownership

BELT TRANSMISSIONS



Dynamic Tensioner Devices: **MB Motorbase**



- Fast and safe belt change, no realignment required
- Compensation of high start-up torque
- Constant transmission
- Better drive performance
- Energy cost savings
- Also available with ATEX specifications



SHOCK ABSORBERS

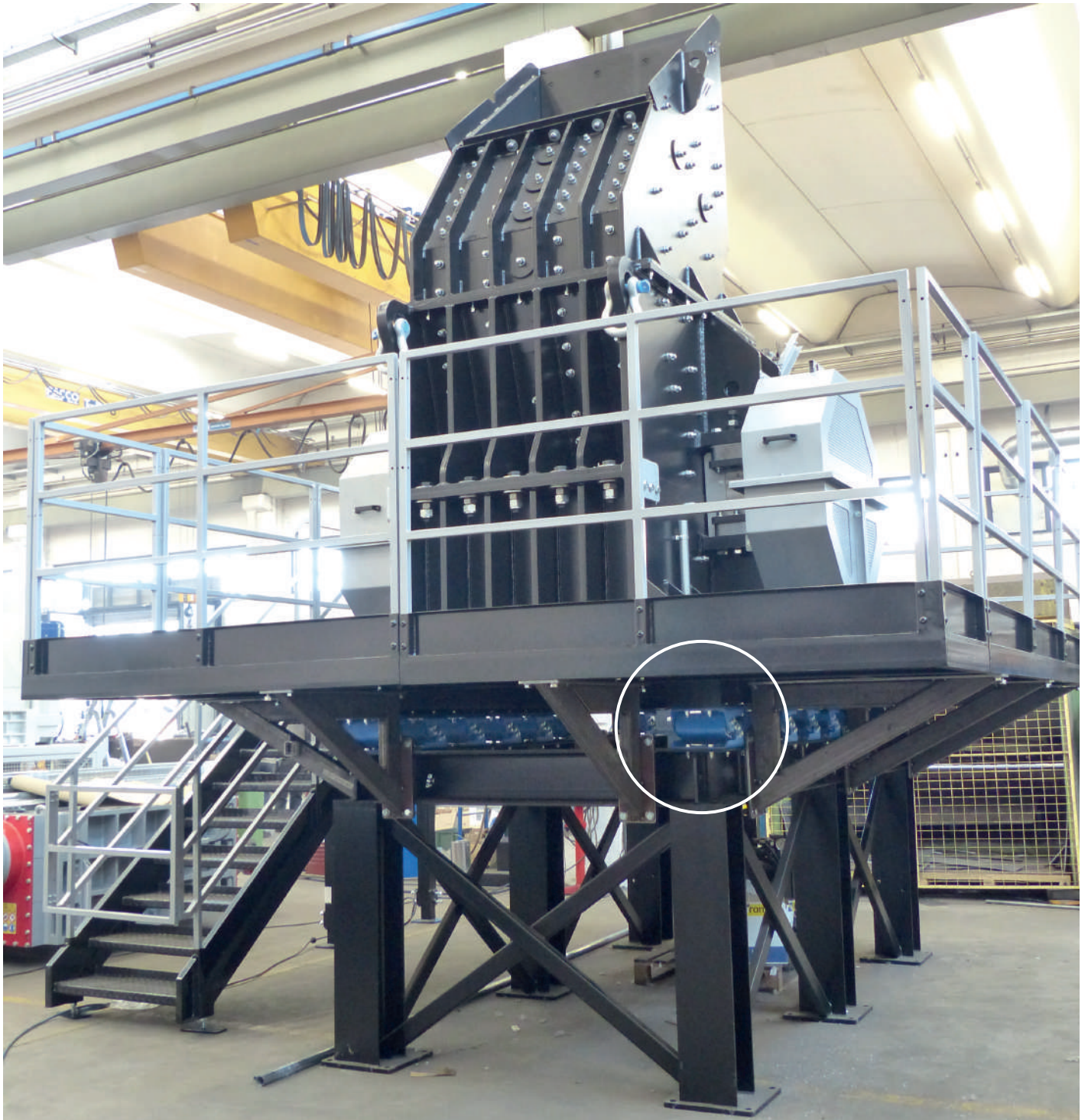

Anti-Vibration Mounts: ESL & V



- Low frequencies and a high damping effect
- Good isolation of impacts and vibrations
(High absorption of reactive forces)
- Absorbing solid-borne noise

FREE OSCILLATING SYSTEMS

Free oscillating systems include screening machines, vibrating feeders and shaking conveyors which require reliable, high-performance suspension components. ROSTA offers a wide range of oscillating mountings for these types of machinery. **ROSTA's range of OSCILLATING MOUNTINGS provide dependably reliable performance and durability with zero-maintenance to provide best-in-class levels of isolation and efficiency for all free oscillating vibrating systems.**

CUSTOMER BENEFITS



Maintenance Free



Reduction of
Noise & Vibration



Safe for User



Long Life Cycle

FEEDERS

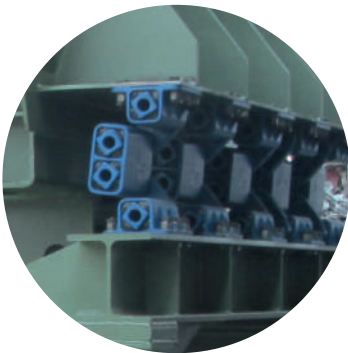

Oscillating Mountings:
AB / AB-HD / AB-D / AB-LF (Pat. Pending)

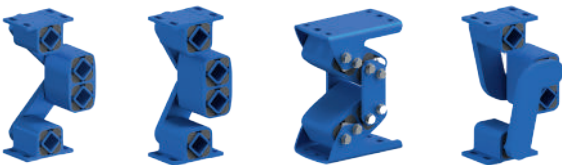

- High oscillation performance (screen side)
- Effective isolation (frame side up to 98%)
- No lateral tumbling
- Shortens the run-out phase considerably
- Overload/impact proof
- No "anti-pinch protection" required
- Long service life



CIRCULAR & LINEAR SCREENS

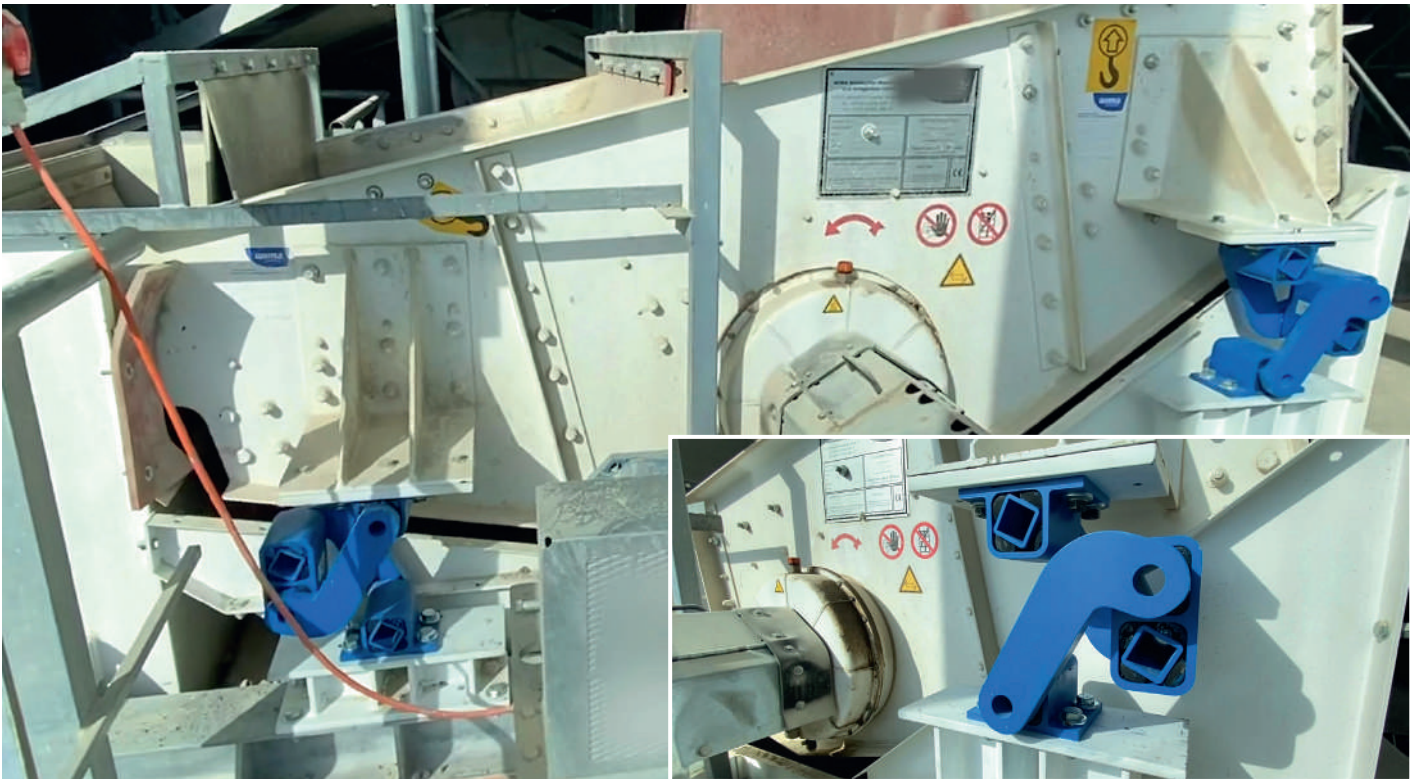

Oscillating Mountings:

AB / AB-HD / AB-D* / AB-LF (Pat. Pending)

For circular and linear motion screens including heavy duty loading and systems with counter frame mounting

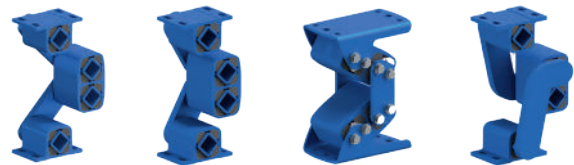

- High oscillation performance (screen side)
- Effective isolation (frame side up to 98%)
- No lateral tumbling
- Shortens the run-out phase considerably
- Overload/impact proof
- No “anti-pinch protection” required
- Long service life

AB-HD: Similar benefits as AB, with heavy duty capacities. AB-D: Similar benefits as AB, for classic frame and counter frame mounting systems

* Linear screens only



SPIRAL CONVEYORS

Oscillating Mountings: **AB-D** – for spiral conveyors



- High isolation effect
- Oscillations to the highest spiral guaranteed
- Compact design
- Stable spiral tower
- No additional fall-prevention devices needed
- Smaller number of suspensions required versus other solutions



HANGING SYSTEMS

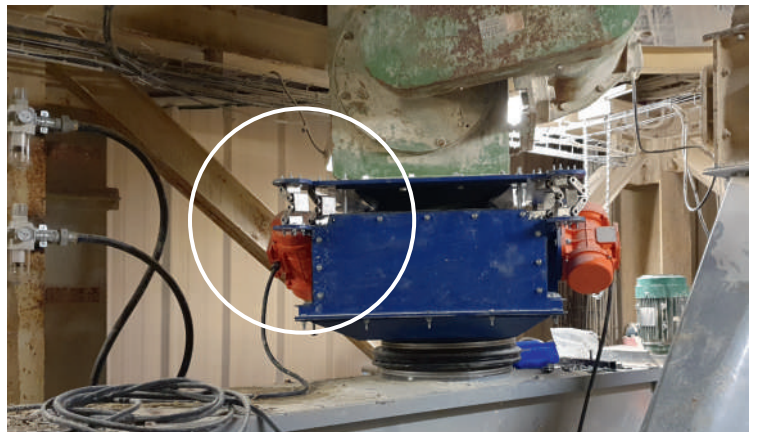

Oscillating Mountings: **HS / HSI**

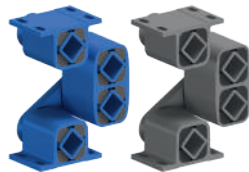

- Designed for hanging loads
- No safety risks
- High oscillation performance (screen side)
- Effective isolation (frame side up to 98%)
- No lateral tumbling
- Shortened the run-out phase considerably
- Overload/impact proof
- No “anti-pinch protection” required
- Long service life



MOBILE SCREENS

Mobile screens are designed for rubble and debris screening of material coming from construction and demolition, excavations waste, compost, asphalt, rocks, etc.

They are usually equipped with a vibrating deck fitted on suspensions. They operate in the most difficult access areas and have the advantage of being able to be moved quickly from one work site to another.



Oscillating Mountings: **AB / AB-D / AB-HD** for mobile applications



- Strong linear motion
- Controlled oscillating motion
- No violent shaking at start up & shut down
- Long service life
- Good corrosion resistance
- No shear breakage
- Anti-tear and safety
- No additional equipment required for transport

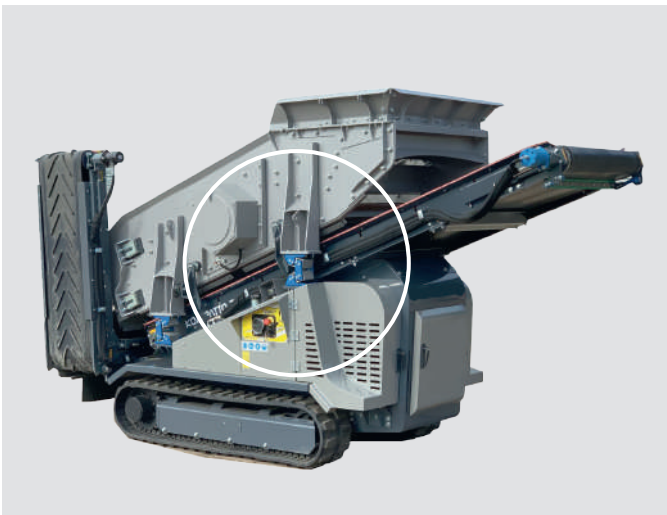

GUIDED SYSTEMS

Oscillating shaker conveyors with crank shaft drives are widely used for the transportation and selection of materials such as copper, electronic scrap and plastics. There are one mass shaker conveyor systems or so-called brute force shaker conveyors, one mass shaker conveyor systems equipped with spring accumulators and two mass shaker conveyor systems with direct reaction force-compensation. All those shaker designs require special springs and rockers. **ROSTA has them all. From single rockers to double rockers including the elements for spring accumulation and drive heads.**

CUSTOMER BENEFITS



Maintenance Free



Long Life Cycle
(MTBF)



Reduction of
Noise & Vibration



Lower Total Cost
of Ownership

ONE MASS SHAKER SYSTEMS



Oscillating Mountings: AU – Single Rocker

- Excellent trough guidance
- Smooth and long stroke motions
- Conveying speed up to 15 m/min
- Trough lengths up to 15 meters



Oscillating Mountings: ST – Drive Head

- Elastic drive head
- Damping dead centers
- For alternating loads
- For crank shaft driven shakers conveyors

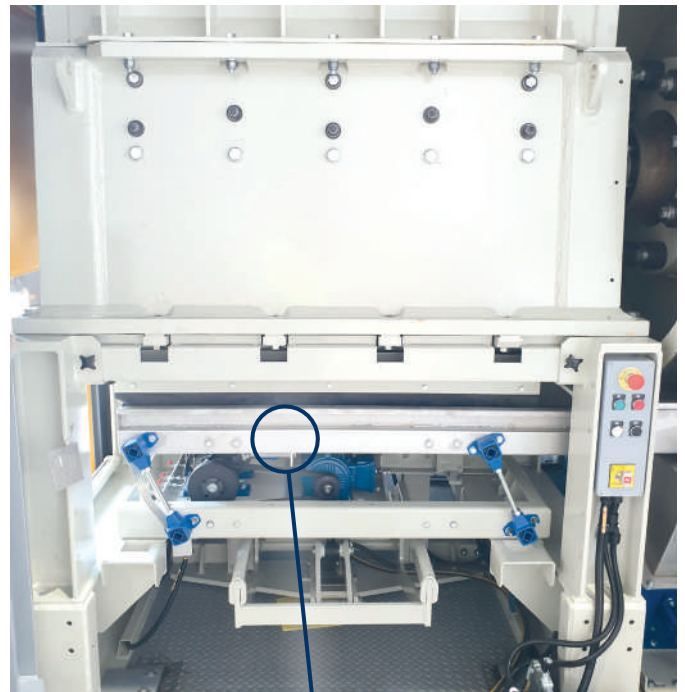

ONE MASS SHAKER “NATURAL FREQUENCY” SYSTEMS



Oscillating Mountings: **AU – Single Rocker** **DO-A – Spring Accumulator**



- For actuation close by resonance frequency (natural frequency systems)
- Compensate the hard hits of crank shaft drive (dead center)
- High dynamic stiffness: heavily supporting the eccentric trough motion
- Conveying speed up to 22 m/min
- Trough lengths up to 20 meters

TWO MASS SHAKER SYSTEMS

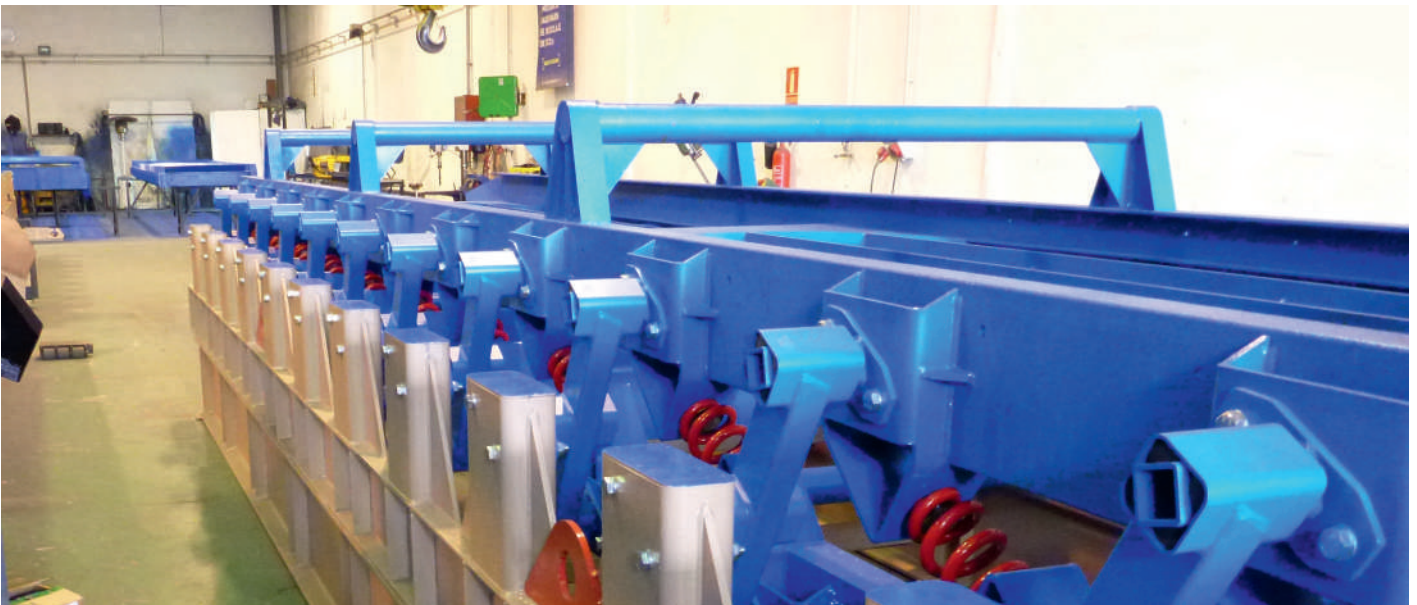

Oscillating Mountings: **AD-P / AD-C – Double Rocker**



- Excellent trough guidance
- Smooth and long stroke motions
- Damping dead centers
- Acceleration up to 5.0 g
- Conveying speed up to 45m/min
- Trough lengths up to 30 meters

ROSTA INSIDE

SEPARATORS

Good quality recycling depends on reliable sorting machines. Separators used in this process need to operate at optimum capacity to ensure that the recycled yield is free of contaminants. ROSTA components not only help to reduce maintenance costs but also to reduce excessive vibrations and friction.

CUSTOMER BENEFITS



Maintenance Free



Long Life Cycle
(MTBF)



Reduction of
Noise & Vibration



Lower Total Cost
of Ownership

GYRATORY SIFTERS



Oscillating Mountings:
AK – universal joint for
support or suspension



- High load capacity (up to 40'000 N)
- For hanging and staying applications
- Smooth guidance and noise reduction
- Long life
- Maintenance free





Oscillating Mountings: **DO-C – Single Rocker**

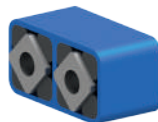

- Efficient spring accumulators
- Highest flow capacity
- Facilitate long stroke motions

Oscillating Mountings: **AB-D – for linear motion screens**



- Purely linear motion – no lateral tumbling
- Allows more efficiency
- shortened the run-out phase considerably
- Absorbing efficiently solid-borne noise and dynamic forces
- Overload/impact proof

BALLISTIC SEPARATORS



Rubber Suspensions:

DR – Steel Tube

DK – Aluminum Profile

- Elastic bushing with high damping effect
- Energy and solid-borne noise absorbing
- Perfect guidance
- Protects the interfaces (screws, rods, shafts, frame)

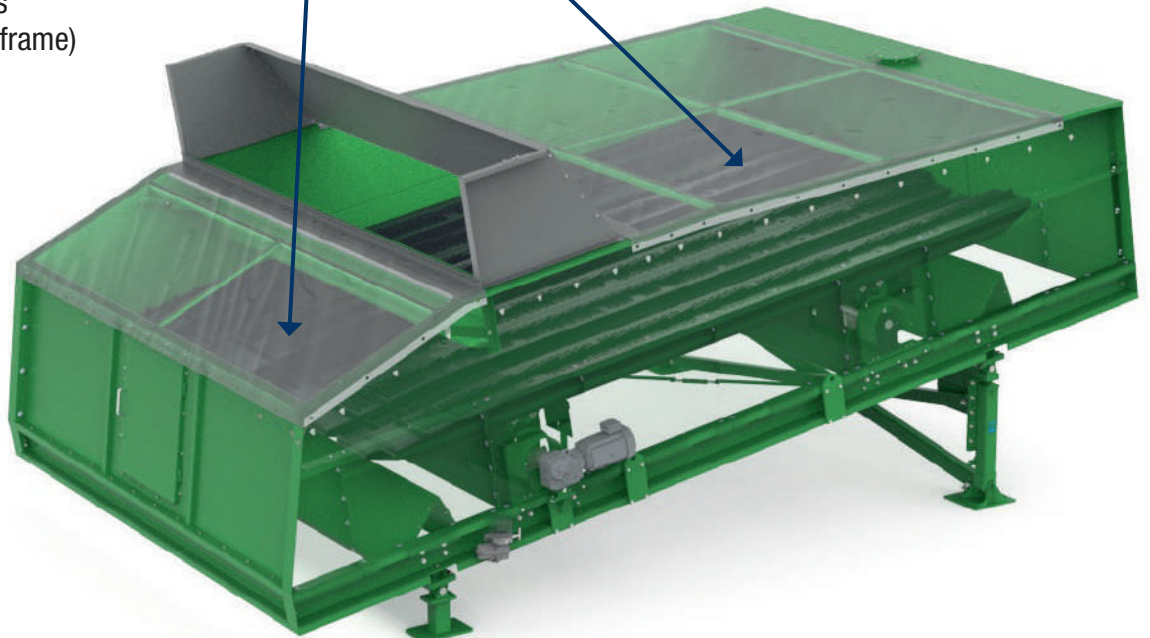

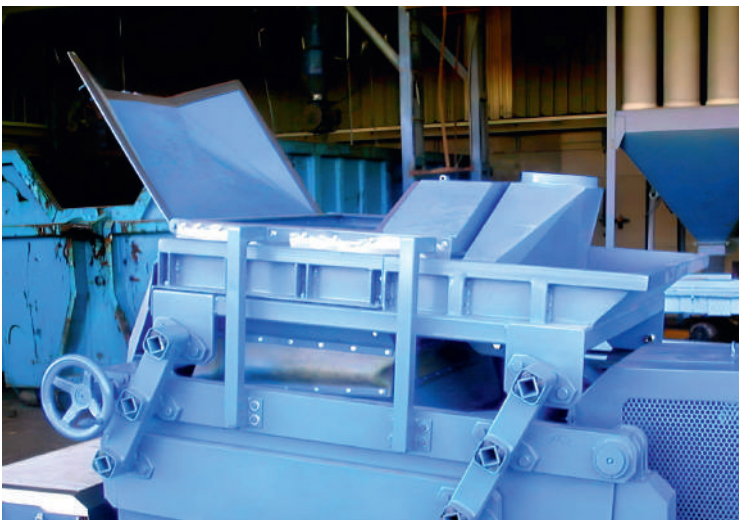

Oscillating Mountings: AD-P – Double Rocker

- Excellent trough guidance
- Smooth and long stroke motions
- Damping dead centers
- Reduced number of rocker arms
- Long life solution



OUR PORTFOLIO



MOTORBASES

Self-tensioning motor mounts
for all friction belt drives

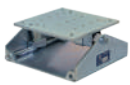

MB 38



MB 50



MB 75



MB 100



TENSIONER DEVICES

Tensioner systems for
belt and chain drives



SE



SE-B



SE-I



P



R-RL



WS



N



OSCILLATING MOUNTINGS

Elastic suspensions for
screening and conveying



AB



AB-HD



AB-D

AB-LF



HS



AU



DO



AR



AS-C/P



AD-C/P



AV



AK



ST



Can't find what you need in the catalog?

Our engineering team specializes in developing tailored solutions to meet your requirements.



VIBRATION DAMPERS

Components for shock and vibration absorbing



ESL



V



AWI



NE



N



NOX



RUBBER SUSPENSION ELEMENTS

Multifunctional and adaptable suspension elements



DR

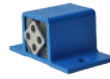

DW



DO



DK



BR/BK



WS



ROSTA DIGITAL

Industry 4.0
Monitoring your process and reduce downtimes



SENSORICS

DASHBOARD



DATA ANALYST



TENSIONING

DAMPENING

CONVEYING

PRESSING

GUIDING

ROSTA SUPERIOR SWISS QUALITY AT A GLANCE

ESTABLISHED HERITAGE: Founded in Switzerland in 1944, our roots embody a legacy of superior quality and precision that is recognized worldwide.

IMPRESSIVE SALES VOLUME: Our commitment to quality and reliability, across all our core markets, has resulted in an impressive annual sales volume of over 1.5 million units.

QUALITY ASSURANCE: Our commitment to quality is reinforced by rigorous in-house quality processes and our ISO certification, ensuring our products meet the highest standards.

CUSTOMIZED SOLUTIONS: We are known for developing tailored solutions to meet the specific needs of our clients, setting us apart in our markets.



GLOBAL FOOTPRINT: Our strategic worldwide presence allows us to spread our Swiss quality on a global scale.

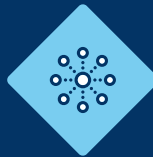

EXTENSIVE DISTRIBUTION NETWORK: We ensure our industry-specific products reach a wide array of customers through our robust distribution network, extending across over 40 countries.



IN-HOUSE PRODUCTION: With most of our production taking place in Switzerland, we maintain full control over the quality and efficiency of our manufacturing process.



UNPARALLELED CUSTOMER SUPPORT: Our global presence is strengthened by personalized customer support, offering assistance and guidance to customers across all five continents.



CORE MARKETS: Specializing in five core markets – recycling, mining, agriculture, food & beverage, and eMobility – our expertise also extends to various other markets, enabling us to serve a wide range of customer needs effectively.



COLLABORATIVE INNOVATION AT OUR CORE: Our R&D department works closely with application engineers, fostering a culture of innovative and customized solutions, continuously evolving to meet market trends and demands.

SERVING OUR CUSTOMERS WORLDWIDE

HEADQUARTERS

ROSTA AG SWITZERLAND

Hauptstrasse 58
CH-5502 Hunzenschwil
+41 (0)62 889 04 00
info.ch@rosta.com
rosta.com



ROSTA SALES OFFICES



GERMANY

+49 (0)2336 47 95 80
info.de@rosta.com

CHINA

+86 21 5428 9775
sales@rostachina.com

ITALY

+39 2 93655 101
rostitalia@rosta.com

USA

+1 269 841 5448
info@rosta.com

CANADA

+1 905 642 6996
info.canada@rosta.com

AUSTRALIA

+61 1 300 169 881
sales.aus@rosta.com

ROSTA DISTRIBUTION PARTNERS



For information about our distribution partners worldwide please use the qr-code or visit www.rosta.com/en/distribution-partners

ISO 9001
ISO 14001

BUREAU VERITAS
Certification



Quality Control: For our customers ISO standards are a guarantee of constant quality and performance. ROSTA is an ISO 9001 and ISO 14001 certified company.

ROSTA AG
SWITZERLAND

Hauptstrasse 58
CH-5502 Hunzenschwil
+41 (0)62 889 04 00
info.ch@rosta.com
rosta.com



Download
Brochure

 **Swiss made**

Your ROSTA Contact

